

**ПРАКТИЧЕСКИЙ КУРС
АНГЛИЙСКОГО ЯЗЫКА
ДЛЯ СТУДЕНТОВ
ИНЖЕНЕРНЫХ
СПЕЦИАЛЬНОСТЕЙ**

**PRACTICAL ENGLISH
COURSE FOR
ENGINEERING
STUDENTS**



Министерство образования Республики Беларусь
Учреждение образования
«Белорусский государственный университет
информатики и радиоэлектроники»
Факультет компьютерного проектирования
Кафедра иностранных языков

ПРАКТИЧЕСКИЙ КУРС АНГЛИЙСКОГО ЯЗЫКА ДЛЯ СТУДЕНТОВ ИНЖЕНЕРНЫХ СПЕЦИАЛЬНОСТЕЙ

PRACTICAL ENGLISH COURSE FOR ENGINEERING STUDENTS

*Рекомендовано УМО по образованию в области информатики
и радиоэлектроники в качестве пособия для специальностей*

- 1-36 04 01 «Программно-управляемые электронно-оптические системы»,
1-40 05 01 «Информационные системы и технологии (по направлениям)»,
1-58 01 01 «Инженерно-психологическое обеспечение информационных
технологий»,
1-98 01 02 «Защита информации в телекоммуникациях»,
групп специальностей
39 01 «Схемы радиоэлектронных устройств и систем»,
39 02 «Конструкции радиоэлектронных средств»,
39 03 «Проекты радиоэлектронных систем и их применение на объектах»,
41 01 «Радио-, микро- и наноэлектронная техника»,
45 01 «Инфокоммуникационные технологии и системы связи»

Минск БГУИР 2022

УДК 811.111(075.8)
ББК 81.2Англя73
П69

Авторы:

И. Г. Маликова, И. И. Лихтарович, Т. В. Левкович, А. М. Лазаренко,
А. П. Дробышева, О. В. Андреева, А. И. Перевышко,
Е. В. Юшкевич, С. Е. Кушнерова

Рецензенты:

кафедра профессионально ориентированной английской речи учреждения
образования «Белорусский государственный экономический университет»
(протокол № 7 от 25.02.2022);

доцент кафедры истории и грамматики английского языка учреждения
образования «Минский государственный лингвистический университет»
кандидат филологических наук, доцент Т. А. Дерман

**Практический курс английского языка для студентов инженерных
П69 специальностей : пособие = Practical English Course for Engineering
Students / И. Г. Маликова [и др.]. – Минск : БГУИР, 2022. – 208 с.
ISBN 978-985-543-669-1.**

Представляет собой систематизированный практический курс английского языка, целью которого является совершенствование навыков, а также развитие умений чтения и понимания англоязычной научно-технической литературы во взаимосвязи с другими видами речевой деятельности: говорением, аудированием и письмом.

Состоит из четырех модулей: Electronics; Telecommunications; Information Technologies; Artificial Intelligence.

Разработанная на основе модульного подхода структура, организация и изложение учебного материала позволяют использовать пособие как для аудиторной, так и для самостоятельной работы.

Предназначено для студентов I ступени высшего образования, изучающих учебную дисциплину «Иностранный язык». Может быть полезно широкому кругу читателей, желающих совершенствовать навыки и развивать умения чтения и понимания англоязычной научно-технической литературы.

**УДК 811.111(075.8)
ББК 81.2Англя73**

ISBN 978-985-543-669-1

© УО «Белорусский государственный
университет информатики
и радиоэлектроники», 2022

ПРЕДИСЛОВИЕ

Данное пособие предназначено для студентов I степени высшего образования дневной, заочной и дистанционной форм обучения.

Цель пособия – совершенствование у студентов навыков чтения и понимания англоязычной научно-технической литературы во взаимосвязи с другими видами речевой деятельности, такими как говорение, аудирование и письмо, что осуществляется через комплекс упражнений, разработанный на основе модульной технологии.

Модульная технология реализуется в структурной организации материала по совершенствованию лексико-грамматических навыков и развитию умений читать и понимать литературу по специальности и предусматривает тщательный отбор языкового материала, объединение логически связанных относительно самостоятельных частей в модули с последующим выделением дифференциальных признаков и созданием комплекса упражнений, адекватных поставленной цели.

Пособие включает четыре модуля определенной тематики, в которых представлен следующий грамматический материал: 1) Electronics (The Predicate); 2) Telecommunications (The Extension of the Simple Sentence and its Structure); 3) Information Technologies (The Compound and Complex Sentences); 4) Artificial Intelligence (The Infinitive, Participial and Gerundial Constructions).

Каждый из модулей включает:

- схемы, в которых выделяются функции и значения логически связанных грамматических явлений на основе совокупности их инвариантных дифференциальных признаков, помогающих установить сходство и различие изучаемых явлений;

- дифференцировочные упражнения с включением оппозиционного противопоставления интерферирующих грамматических явлений;

- предтекстовые, текстовые и послетекстовые упражнения для овладения технологией чтения с различными целевыми установками;

- условно-речевые и речевые упражнения для совершенствования навыков и развития умений говорения по заданной тематике.

В пособии модули расположены по принципу доминантности и преемственности. В каждый последующий модуль включаются грамматические явления, изученные в предыдущем, что способствует их лучшему распознаванию и пониманию.

Каждый модуль состоит из двух частей (Part I и Part II), содержащих по четыре текста: Reading 1, Reading 2, Reading 3 и Summary Writing, предназначенные для развития умений работы над соответствующим видом чтения. Reading 1 предназначен для работы над ознакомительным чтением, Reading 2 направлен на развитие умений изучающего чтения, Reading 3 используется для обучения просмотровому чтению. Статья для Summary Writing

развивает умения краткого изложения основного содержания прочитанного материала.

Представленные в пособии разнообразные задания дискуссионных видов деятельности дают возможность студентам совершенствовать речевую компетентность, умение анализировать и обобщать материал, представлять и аргументировать свою точку зрения на обсуждаемые проблемы. К ряду упражнений приводятся QR-коды, которые включают ссылки на мультимедийные источники и ресурсы, содержащие дополнительную информацию по изучаемой теме, а также ряд заданий. Использование QR-технологии предоставляет возможность обучаемым получить быстрый доступ к искомому цифровому ресурсу и сразу же приступить к работе, позволяя тем самым повысить мотивацию студентов и интенсифицировать процесс обучения.

Используемые в пособии аутентичные материалы отобраны из современных англо-американских источников, а также интернет-ресурсов, охватывающие наиболее значимые и перспективные области современной инженерии, анализирующие достижения и направления дальнейшего развития данных областей науки и техники, соответствующие профилю вуза. Все используемые материалы снабжены ссылками на первоисточники.

Данное пособие может быть использовано как для аудиторной, так и для самостоятельной работы студентов в рамках программного материала курса изучения английского языка.

BOOK MAP

Modules	Reading and Speaking	Video and Speaking	Writing	Grammar
<p>Module 1 ELECTRONICS</p> <ul style="list-style-type: none"> • Electronic technologies • Electronics application 	<ul style="list-style-type: none"> • extensive reading • intensive reading • text skimming • defining statements as «true» or «false» • discussing questions and comparing ideas • expressing points of view • role play 	<ul style="list-style-type: none"> • listening for detailed comprehension • expressing agreement/dis-agreement • exchanging opinions 	<ul style="list-style-type: none"> • summary writing 	<ul style="list-style-type: none"> • The Predicate
<p>Module 2 TELECOMMUNICATIONS</p> <ul style="list-style-type: none"> • Networking • Wireless communication 	<ul style="list-style-type: none"> • extensive reading • intensive reading • text skimming • giving reasons • answering questions in pairs • explaining your choice • role play 	<ul style="list-style-type: none"> • listening for gist • «true»/ «false» statements • discussing questions • justifying your point of view 	<ul style="list-style-type: none"> • summary writing 	<ul style="list-style-type: none"> • The Extension of the Simple Sentence and its Structure
<p>Module 3 INFORMATION TECHNOLOGIES</p> <ul style="list-style-type: none"> • Operating systems and programming languages • Cutting edge technologies and cyber security 	<ul style="list-style-type: none"> • extensive reading • intensive reading • text skimming • discussing questions in pairs • giving reasons • commenting on quotes • role play 	<ul style="list-style-type: none"> • extensive listening • sharing ideas • discussing problems 	<ul style="list-style-type: none"> • summary writing 	<ul style="list-style-type: none"> • The Compound and Complex Sentences
<p>Module 4 ARTIFICIAL INTELLIGENCE (AI)</p> <ul style="list-style-type: none"> • Basic AI concepts • AI in everyday life 	<ul style="list-style-type: none"> • extensive reading • intensive reading • text skimming • expressing your attitude • brainstorming ideas • role play 	<ul style="list-style-type: none"> • listening for gist • «true»/ «false» statements • comparing facts and ideas 	<ul style="list-style-type: none"> • summary writing 	<ul style="list-style-type: none"> • Participial, Gerundial and Infinitive Constructions

MODULE 1 ELECTRONICS

Grammar: THE PREDICATE

PART I

ELECTRONIC TECHNOLOGIES

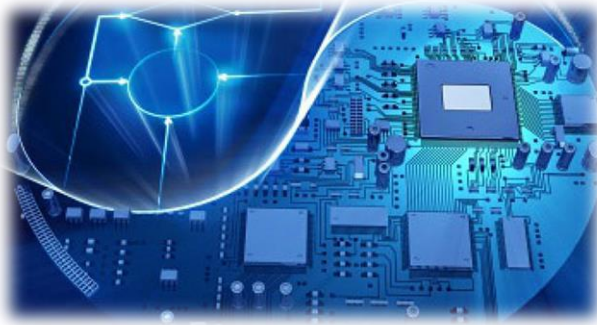

«Electronics is clearly the winner of the day».

John Ford

STARTING UP

I. A. Have you ever confused the terms «electrical» and «electronic»? What is the difference between them? Share your ideas with a partner.

B. In pairs, put the sentences given below into the correct column. Justify your choice.

1. This technology deals with designing, amplifying, and switching electrical energy with the help of different electronics equipment.
2. This technology deals with the generation, distribution, storage, and conversion of electrical energy/power, etc.
3. These devices are created with semiconductor substances such as silicon, germanium, etc.
4. These devices are used to perform mechanical work.
5. In this circuit, electrical energy consists of the flow of electrons.
6. These devices use DC (direct current) for their operation.
7. For conduction in these devices, metallic substances such as copper and aluminium are used.
8. Due to their small sizes, they need less space.
9. These devices perform the manipulation of data.
10. The main working principle of these instruments is that they transform electrical energy into other types of energy.

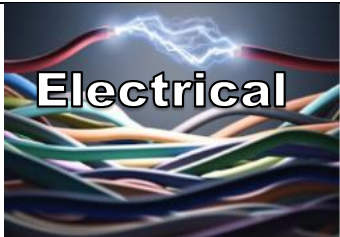
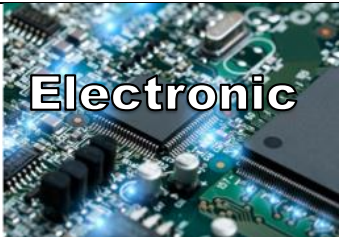
	VS	

II. In pairs, discuss the following questions.

1. How has electronics changed the life of people?
2. What do you know about the most important breakthroughs in electronics?
3. What is the future of electronics?

III. Make a list of achievements and inventions in electronics you consider most essential for its development. Compare your ideas with those of your groupmates. Are your views similar or different?

READING 1

I. Scan the text and choose the best title.

1. THE FUTURE OF ELECTRONICS.
2. DEVELOPMENT OF ELECTRONICS.
3. DOMESTIC ELECTRONIC DEVICES.
4. THE USE OF ELECTRONICS IN PHYSICS.

Electronics is a field of engineering and applied physics dealing with the design and application of electronic circuits. The operation of circuits depends on the flow of electrons for generation, transmission, reception and storage of information.

Today it is difficult to imagine our life without electronics. It surrounds us everywhere. Electronic devices are widely used in scientific research and industrial designing, they control the work of plants and power stations, calculate the trajectories of spaceships and help people discover new phenomena of nature. Automatization of production processes and studies on living organisms became possible due to electronics.

The invention of vacuum tubes at the beginning of the 20th century was the starting point of the rapid growth of modern electronics. Vacuum tubes assisted in manipulation of signals. The development of a large variety of tubes designed for specialized functions made possible the progress in radio communication technology before World War II and in the creation of early computers during and shortly after the war.



Vacuum Tubes

The transistor invented by American scientists W. Shockly, J. Bardeen and W. Brattain in 1948 completely replaced the vacuum tube. The transistor, a small piece of a semiconductor with three electrodes, had great advantages over the best vacuum tubes. It provided the same functions as the vacuum tube but at reduced weight, cost, power consumption, and with high reliability. With the invention of

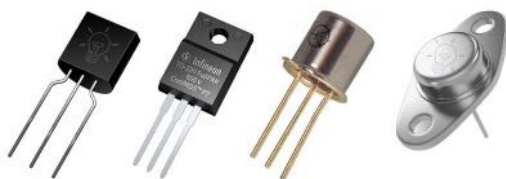

Transistors

the transistor all essential circuit functions could be carried out inside solid bodies. The

aim of creating electronic circuits with entirely solid-state components had finally been realized. Early transistors could respond at a rate of a few million times a second. This was fast enough to serve in radio circuits, but far below the speed needed for high-speed computers or for microwave communication systems.

The progress in semiconductor technology led to the development of the integrated circuit (IC), which was discovered due to the efforts of John Kilby in 1958. There appeared a new field of science – integrated electronics. The essence of it is batch processing. Instead of making, testing and assembling discrete components on a chip one at a time, large groupings of these components together with their interconnections were made all at a time. IC greatly reduced the size of devices, lowered manufacturing costs and at the same time they provided high speed and increased reliability.

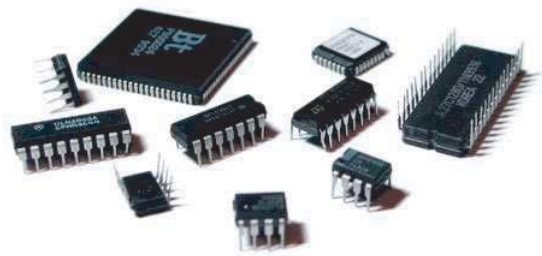

Integrated Circuits

(<https://lingualeo.com/ru/jungle/unit-2-text-1-development-of-electronics-532711>)

II. Read the text and write out key words and phrases revealing the content of the text.

III. Divide the text into logical parts. In each part find the topical sentence.

IV. Read the statements below and decide which of them correspond to the content of the text.

1. Electronic engineering is an engineering discipline concerned with the design and application of equipment which use electricity.

2. Electronic devices help us in every sphere of life including scientific investigations, the work of enterprises and power stations, space and nature research.

3. Advances in radio communication technology became possible due to vacuum tubes.

4. After World War II, transistors were used to develop the first computers.

5. John Bardeen, Walter Brattain, and William Shockley were awarded the Nobel prize for their invention of the transistor in 1956.

6. Integrated electronics came into being due to the advances in semiconductor technology.

7. Unlike batch processing, stream processing is the process of analyzing streaming data in real time.

V. In the text find the sentences containing the information about the following elements:

- vacuum tubes;
- transistors;
- integrated circuits.

VI. Explain the importance of these elements for further development of electronics.

VII. Look through the text and find the sentences which prove that:

1. Electronics has penetrated into all spheres of our life.
2. The invention of vacuum tubes triggered the fast development of modern electronics.
3. The transistor had great benefits compared to the best vacuum tubes.
4. Batch processing is a key point of integrated electronics.

VIII. Sum up the text using key words, word combinations and topical sentences.

IX. Express your attitude to the facts given in the text. Use the following phrases:

- From my point of view _____.
- I'd like to mention briefly that _____.
- The text gives valuable information on _____.
- I find the text rather interesting/ cognitive because _____.
- In my opinion the text is important/ useful as/ because _____.

X. Say what information of the text is new to you and what inventions you find most significant.

GRAMMAR FOCUS 1

1.1. Исходные структурные элементы сказуемого

(to) x ¹ = делать	xed = сделанный	xing = делающий
<i>to use</i> = использовать	<i>used</i> = использованный	<i>using</i> = использующий
<i>to give</i> = давать	<i>given</i> = данный	<i>giving</i> = дающий
Инфинитив (Infinitive) – словарная форма	Причастие II (Participle II) – причастие пассивное	Причастие I (Participle I) – причастие активное
The company started <i>to develop</i> integrated products.	Integrated products are <i>developed</i> by the company.	The company is <i>developing</i> integrated products.

¹Символ «x» – это универсальное обозначение любого знаменательного английского слова.

I. Name the Infinitive, Participle I, Participle II. Define their specific features:

a) to communicate; changed; developing; to get; expressing; expected; to carry; involved; to understand; counting; to help; replaced; to meet; installed; changing; to calculate; to open; transformed; recording; realized; to read; created; forming; to follow.

b) to connect – connected – connecting; to block – blocking – blocked; to call – called – calling; to place – to replace – replaced – replacing; to act – to activate – activated – activating; to code – encoded – encoding – decoded – decoding; to charge – to discharge – discharged – recharged – recharging; to use – reused – misused – using – reusing – misusing.

**1.2. Сказуемое с глаголом to have
(to have – had – had)**

Признаки распознавания функций и значений глагола to have

Синтаксическая функция и значение	Пример
1. Смысловой глагол со значением «иметь», «обладать» (перед именем существительным, числительным, местоимением).	These parts <i>have</i> complex shapes.
2. Вспомогательный глагол для образования времен Perfect (перед причастием прошедшего времени).	The digital integrated circuits <i>have become</i> commonplace.
3. Модальная конструкция have to с инфинитивом глагола имеет значение необходимости выполнения действия и переводится как «нужно», «должен», «необходимо», «обязан».	The engineers <i>have to</i> examine this device.

II. Define the function and meaning of the verb to have. Give the Russian equivalents of the sentences.

1. The microprocessor has a sophisticated instrument set. 2. My assistant had done all the preparatory work by 9 o'clock. 3. The design has to be simple and of low cost. 4. The computers have created entirely new technical possibilities. 5. The transistor had the potential to work faster and more reliable than a vacuum tube. 6. Modern engineers have to deal with a lot of technological innovations. 7. The scientists of our laboratory had been carrying out new experiments for several months before they got positive results. 8. They had to improve the device to obtain more accurate data. 9. The high level of flexibility and reliability of transistors have a great significance in modern microelectronics. 10. The aim of creating electronic circuits with entirely solid-state components had finally been realized.

**1.3. Сказуемое с глаголом to be
(to be – was, were – been)**

Признаки распознавания функций и значений глагола to be

Синтаксическая функция и значение	Пример
1	2
1. Смысловой глагол со значением «быть», «находиться» (когда за ним следует существительное с предлогом или наречие).	The world <i>is</i> in the midst of an electronic revolution.
2. Глагол-связка (в сочетании с предикативом) со значением «быть»,	A triode <i>is</i> a valve with three electrodes.

1	2
«являться», «состоять», «закключаться».	Electronics <i>is</i> one of the branches of science and technology. His aim <i>is</i> to obtain these data.
3. Вспомогательный глагол для образования форм: а) Continuous и Perfect Continuous; б) страдательного залога.	а) Our scientists <i>are developing</i> new types of electronic devices. б) This 64-bit microprocessor <i>was manufactured</i> by AMD.
4. Модальная конструкция be to с инфинитивом глагола имеет значение запланированности действия и переводится как «должен», «необходимо», «следует».	We <i>were to</i> begin our experiment last week.

III. Define the function and meaning of the verb to be. Give the Russian equivalents of the sentences.

1. Everything is in constant motion. 2. The experts are to take into account the results of the test. 3. Thanks to computers we are processing information million times quicker now. 4. The purpose of this catalyst is to accelerate the process of chemical reaction. 5. The results of the last experiment were used to improve the reliability of the device. 6. We had been conducting this experiment for two hours before you came. 7. The charges of an electron and of a proton are equal in strength. 8. Commercially available thin- and thick-film circuits are combinations of integrated and discrete components. 9. A new type of computing equipment is being produced at our plant. 10. They are to become the basis for the solution of a great number of economic and scientific problems.

1.4. Сказуемое с глаголом to do (to do – did – done)

Признаки распознавания функций и значений глагола to do

Синтаксическая функция и значение	Пример
1	2
1. Смысловой глагол со значением «делать», «проводить», «выполнять», «совершать».	Most computers <i>do</i> serial processing.
2. Вспомогательный глагол: а) для образования вопросительной и отрицательной форм в Present, Past Simple; б) для образования отрицательной формы повелительного наклонения.	а) What <i>does</i> the manufacture of integrated circuits consist of? We <i>didn't see</i> them make this experiment. б) <i>Don't use</i> this tool, it is broken!

1	2
3. Для усиления значения глагола-сказуемого. Имеет значение « <i>все же</i> », « <i>ведь же</i> », « <i>действительно</i> », « <i>несомненно</i> ».	We <i>do realize</i> what great importance this discovery has for the future work.
4. Глагол-заместитель (во избежание повторения смыслового глагола).	The last experiment gave us much better results than <i>did</i> the previous one.

IV. Define the function and meaning of the verb to do. Give the Russian equivalents of the sentences.

1. The electric motor does mechanical work. 2. I don't understand the action of this device. 3. Do not change the temperature. 4. Semiconductors do possess many wonderful properties. 5. What kind of methods did they suggest? 6. Electrical conductors do not form a continuous closed circuit. 7. Digital computers solve problems and do other tasks by counting, comparing, and rearranging digits in the arithmetic/logic unit. 8. The addition of heat does not increase the weight of metal, however, the combination with air does increase its weight. 9. Semiconductors let electric current pass through them more easily than insulators do. 10. The ion does have a definite mobility that does not change with time.

WORD FORMATION

I. Define which of the words below are verbs. Give their Russian equivalents.

Beautiful, recognize, misbehave, storage, sympathy, rewrite, theory, badly, communicate, organize, advise, useful, energy, basic, dislike, reread, criticize, familiar, probably, accelerate, simplify, electronic, transform, deepen, discontinue, experiment, special, enlarge, method, movement, complex, mispronounce, emphasize, decontrol, height, greatness, represent, thicken, combination, unimportant, television, disconnect, replace, commonplace, overwork, development.

II. Explain the way of the word formation of the verbs in bold type. Give their Russian equivalents.

1. Satellites help to **minimize** all the difficulties that may appear. 2. Will traditional newspapers ever **disappear**? 3. You've seen brilliant people **devise** computer viruses that bring down whole systems. 4. These inks are designed to provide better halftones, which are necessary to **reproduce** photographs. 5. We should be able to **overcome** all the difficulties in our research. 6. To **strengthen** the magnetic field means to increase the acceleration of particles. 7. X-rays do not require vacuum as do electrons, which may **simplify** production techniques. 8. The microprocessor **enforces** access to the data on the card. 9. In airport control towers, computers are used to manage radar systems and **regulate** air traffic. 10. The attempts to **miniaturize** electronic components are largely successful.

III. Form all possible verbs adding prefixes or suffixes to the given

a) adjectives:

intensive, central, bright, modern, deep, different, weak, simple, digital, regular, pure, sharp, special, electric, large;

b) nouns:

strength, note, apology, force, memory, crypt, class, utility, origin, theory, length, compass, synthesis, title, circle, code;

c) verbs:

to store, to colour, to generate, to magnetize, to control, to form, to construct, to produce, to move, to organize, to place, to charge, to calculate, to appear, to arrange.

IV. Choose an appropriate word and complete the sentences.

1. Microelectronic technique will continue to **displace/misplace** other modes.
2. What steps can be taken to **misbecome/overcome** the barrier?
3. All of them were made from materials which we now **misclass/classify** as semiconductors.
4. An oscillator is used to **generate/unregenerate** an electrical signal.
5. The operating system **enables/disables** the computer to perform a specific task.
6. The player can utilize an animated platform to **redirect/misdirect** the main character as they move through the stage.
7. I'm trying to make a spreadsheet up to **computerize/precompute** everything that's done by hand at the moment.
8. Solving a problem of poor information security **supposes/presupposes** a complex of measures.

WORD STUDY

I. Match the words to the definitions.

- | | |
|--------------------------------|--|
| 1) accomplish, <i>verb</i> | a) to operate on data by means of a program; |
| 2) capacitor, <i>noun</i> | b) a substance used in electronics whose ability to conduct electricity increases with greater heat; |
| 3) circuit, <i>noun</i> | c) a conclusion or resolution reached after consideration; |
| 4) decision, <i>noun</i> | d) a device that collects and stores electricity; |
| 5) density, <i>noun</i> | e) a set of similar things; |
| 6) direct, <i>verb</i> | f) a closed system of wires through which electricity can flow; |
| 7) noise, <i>noun</i> | g) a measure of the amount of information on a storage medium; |
| 8) process, <i>verb</i> | h) any bad change in a signal, especially in a signal produced by an electronic device; |
| 9) range, <i>noun</i> | i) to finish something successfully or to achieve something; |
| 10) semiconductor, <i>noun</i> | j) to control the operations of; manage or govern. |

II. Match the words to the ones with a similar meaning.

- | | |
|-------------------|------------------|
| 1) to transform | a) to choose |
| 2) device | b) impact |
| 3) to select | c) changeable |
| 4) complementary | d) diversity |
| 5) to perform | e) to change |
| 6) influence | f) to place |
| 7) variety | g) to accomplish |
| 8) to house | h) supplementary |
| 9) to communicate | i) tool |
| 10) variable | j) to transmit |

III. Fill in the gaps with the words given in the box.

a) storage	b) contain	c) commonplace	d) size	e) electronic
f) components	g) variety	h) semiconductor	i) devices	j) circuit

Microelectronic **1.** _____ are made from wafer-thin pieces of **2.** _____ material, such as silicon. A small chip of silicon can **3.** _____ a very large number of **4.** _____ components built into the **5.** _____. Integrated circuits (IC) have a wide **6.** _____ of processing and **7.** _____ functions. Today it is possible to have all circuits needed for a microcomputer, for example, on a single semiconductor chip, which is about the same **8.** _____ as the early ICs that contained only a few **9.** _____. Large-Scale Integrated circuits (LSI), containing thousands of components, are now **10.** _____.

READING 2

I. Read the text and name the key points raised in it.

DIGITAL ELECTRONICS

1. Digital electronics are the electronics that transformed our lives beginning in the 1970s. The personal computer is one of the best examples of this transformation because it has simplified tasks that were difficult or impossible for individuals to accomplish. Digital devices use simple «true-false» or «on-off» statements to represent information and to make decisions. In contrast, analog devices use a continuous system of values. Because digital devices only recognize one of two permissible signals, they are more tolerant to noise and a range of components than analog devices. Digital systems are built of a collection of components that process, store, and transmit or communicate information. The basis of these components is the logic circuit that makes the true-false decision from what may be many true-false signals. The logic circuit is an integrated circuit from any one of a number of families of digital logic devices that use switches, transducers, and timing circuits to function. Digital logic gates are the most elementary inputs and outputs in a logic device.

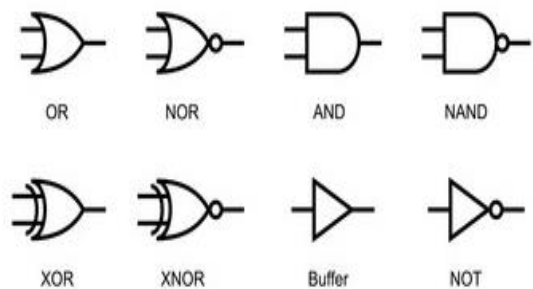

Logic Gate Symbols

A logic gate is based on a simple operation in Boolean algebra (a form of mathematics that uses logic variables to express thought processes). For example, a logic gate may perform an «or», «and», or «not» function; to make it capable of a «nor» function, an «or» gate is followed by an inverter. By linking combinations of these gates, any decision is possible.

2. The most popular form of logic circuit is probably the transistor-transistor logic (TTL) circuit. High-speed systems use emitter coupled logic (ELC), and the complementary metal oxide semiconductor (CMOS) logic uses lower speeds to also lower power levels. Logic gates are also combined to make static-memory cells. These are combined in a rectangular array to form the random-access memory (RAM) familiar to home computer users. The binary digits that make up this memory are called «bits», and typical large-scale integrated (LSI) circuit memory chips have over 16,000 bits of static memory. Dynamic memory cells use capacitors to send memory to a selected cell or to «write» to that cell. Very-large-scale chips with 256,000 bits per chip were made beginning in the 1980s, and dynamic memory made these possible because of its high density.

3. Microprocessors have replaced combinations of switching and timing circuits. They are programmed to perform sets of tasks and a wider variety of logic functions. Electronic games and digital watches are examples of microprocessor systems. Digital



Microprocessors

methods have revolutionized music, library storage, medical electronics, and high definition television, among thousands of other tools that influence our lives daily. Future changes to so called «computer architecture» are directed at greater speed; ultra-high-speed computers may operate by using superconducting circuits that operate at extremely cold temperatures, and

integrated circuits that house hundreds of thousands of electronic components on one chip may be commonplace on our desktops.

(<https://science.jrank.org/pages/2384/Electronics-Digital-electronics.html>)

II. Define the following statements as true (T) or false (F). Correct the false ones.

1. The personal computer is the perfect example of digital electronics that has dramatically changed our lives.
2. Digital and analogue devices apply the same system to represent information.
3. RAM is the basic component that comes to the true-false decision.
4. Boolean algebra is the foundation of a logic gate.
5. Logic gates are put together in a rectangular array to form transistor-transistor logic.
6. Dynamic memory made possible very-large-scale chips due to its high density.
7. Microprocessors are programmed to perform an «or», «and», or «not» function.
8. Digital methods have radically altered different electronic devices.

III. Complete the following sentences choosing the most suitable variant.

1. To represent information and to take decisions digital devices utilize _____.
 - a) simple «and» or «nor-off» statements;
 - b) simple «true-false» or «on-off» statements;
 - c) a continuous system of values.
2. The basis of a collection of components whose function is to process, store, and transmit or communicate information is _____.
 - a) the very-large-scale chip;
 - b) transistor-transistor logic (TTL) circuit;
 - c) the logic circuit.
3. The main inputs and outputs in a logic device are _____.
 - a) dynamic memory cells;
 - b) digital logic gates;
 - c) integrated circuits.
4. The element that uses lower speeds to also lower power levels is _____.
 - a) the complementary metal oxide semiconductor;
 - b) the emitter coupled logic;
 - c) static-memory cells.
5. Switching and timing circuits have been substituted by _____.
 - a) an integrated circuit;
 - b) very-large-scale chips;
 - c) microprocessors.

IV. Read passage 1 and answer the following questions:

1. What marked changes has PC brought to our lives?
2. What is the difference between digital and analogue devices?
3. Why are digital devices more resistant to noise?
4. What is the function of the logic circuit?
5. What is Boolean algebra?

V. Read passage 2 and name the types of logic circuits.

VI. In passages 2 and 3 find the words or word combinations that mean the following:

the most in demand; to be joined; acquainted; having a high concentration; to substitute for; to change radically; to have an impact on; to be frequently found.

VII. In passage 3 find the information to prove that digital methods affect our lives.

VIII. Translate passage 3 into Russian.

IX. Make an outline of the text.

X. Speak on:

1. The advantages of digital devices.
2. The use of logic circuits.
3. Future changes to «computer architecture».

Complete the crossword puzzle using the clues given below.

CROSSWORD PUZZLE ON ELECTRONIC CIRCUITS

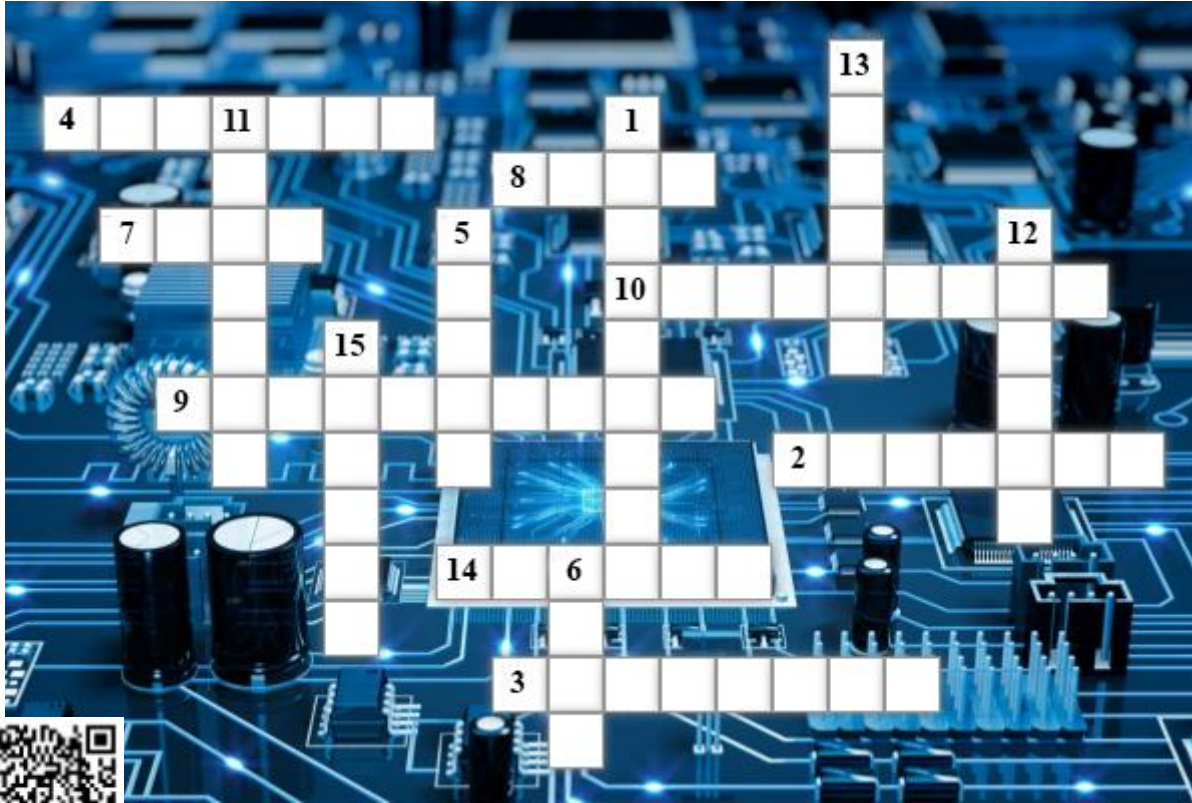

<https://learningapps.org/watch?v=p0mvkt4et21>

Across	Down
2. Source of electric current.	1. Rapidly moving charged particles that carry electrical energy.
3. The device prevents the parts of an electronic device from burning.	5. A good conductor of electricity.
4. A path through which electricity can flow.	6. An electrical circuit that is not complete.
7. A long thin piece of metal that is used to carry electric current.	11. The flow of electric charge.
8. The glass part of an electric lamp.	12. Material used for making conductor wires.
9. This protects us from getting electrocuted.	13. A gap in the conductor where you can close or open the circuit.
10. A device that stores and releases energy much faster than a battery.	15. A bad conductor of electricity.
14. A complete electrical circuit through which current can flow.	

1.5. Личные формы глагола
The Finite Forms of the Verb

1.5.1. Действительный и страдательный залог
Active and Passive Voice

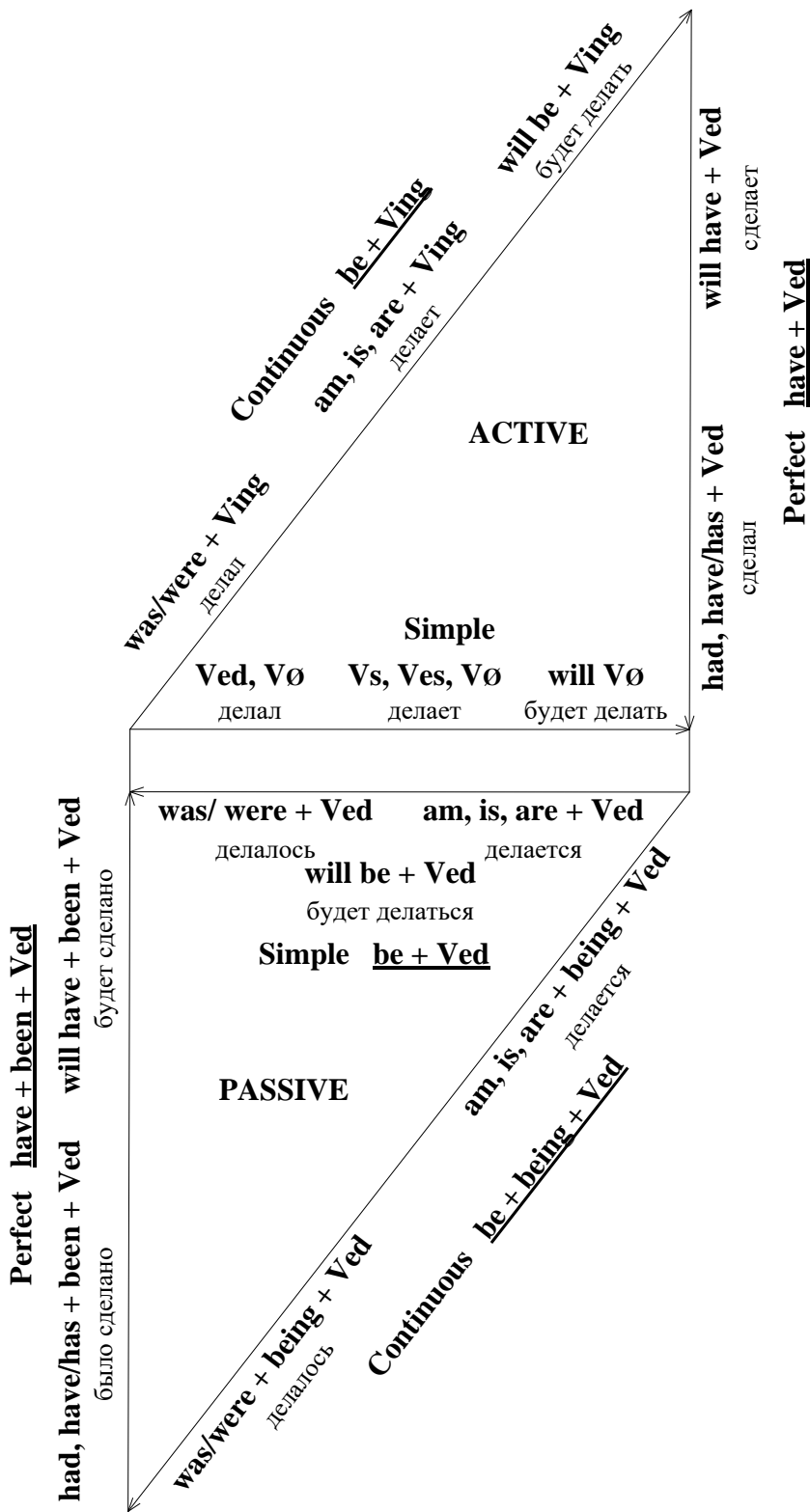

I. Define the predicates in the active form and give their Russian equivalents.

1s were translating; 2 was translated; 3 has been translating; 4 will be translating; 5 will be translated; 6 is translated; 7 has translated; 8 is translating; 9s were being translated; 10s have translated; 11 had been translated; 12 am being translated; 13 will have been translating; 14s have been translated.

II. Define the predicates in the passive form and give their Russian equivalents.

1 is being translated; 2 was translating; 3 has been translated; 4 was being translated; 5 will have translated; 6 am translating; 7 had translated; 8s are translated; 9s were translated; 10s are translating; 11s are being translated; 12 am translated; 13s have been translating; 14 will have been translated.

III. In each pair of sentences below compare the predicates by form and meaning, define their similarities and differences. Give their Russian equivalents.

1. a) Electronic devices give immense extension to our senses. b) Electronics plays the leading role in automation.

2. a) Discrete active components are connected to form a complete circuit. b) Scientists in this laboratory are conducting an interesting experiment.

3. a) Printed circuits have helped to reduce the size of apparatus considerably. b) We have not been informed about the experiments.

4. a) Integrated electronics will move towards new types of functions. b) Many electronic devices will be improved in future.

5. a) They have been discussing this new design for a week. b) This term has been discussed for a long time.

IV. In each sentence find the predicate and give its Russian equivalent.

1. We are still learning how to exploit the potential of integrated circuits. 2. The invention of the transistor triggered the rapid growth of the electronics industry. 3. The results of two model tests will be presented in order to demonstrate the potentials of the model. 4. The semiconductor industry exploits the «whole periodic table» to manufacture its components. 5. A difficult problem is being solved now by engineers. 6. Integrated electronics will move not only towards more functions per slice, but towards new types of functions. 7. Electronics has extended man's intellectual potential. 8. Transistors are made of semi-conductors such as silicon and gallium arsenide. 9. We have not been informed about the experiments. 10. Even before the invention of the transistor the electronics industry had studied the properties of thin films of metallic and insulating materials. 11. In an analogue signal, the signal is varied continuously with respect to the information. 12. The new equipment had been tested for two hours when the chief engineer came and stopped the experiment.

VI. Give the Russian equivalents of the sentences below. Pay attention to the translation of the intransitive prepositional verbs.

1. This date will be insisted on. 2. Many materials now in common use were not even thought of thirty years ago. 3. The properties of these systems were much spoken about. 4. A new modern computer is looked after by a programmer. 5. When something went wrong with the computer, the designer was sent for. 6. The phenomenon is referred to in many articles. 7. This concept is also referred to by some network security people. 8. These rules were arrived at independently. 9. All the machines were looked at with great interest. 10. The new model of the device will be worked at in the plant laboratory.

В. При переводе страдательного залога английских переходных глаголов, которым в русском языке соответствуют глаголы, принимающие предложное дополнение, предлог ставится перед словом, которое в английском предложении является подлежащим.

The results were affected by the presence of impurities.

ПОВЛИЯЛО НА

На результаты повлияло присутствие примесей.

Запомните значения следующих переходных глаголов

to address smb.	обращаться к кому-либо
to affect smb., smth.	влиять, воздействовать на кого-либо, что-либо
to answer smth.	отвечать на что-либо
to follow smb., smth.	следовать за кем-либо, чем-либо
to influence smb., smth.	влиять, оказывать воздействие на кого-либо, что-либо
to watch smb., smth.	следить за кем-либо, чем-либо; наблюдать что-либо

VII. Translate the parts of sentences below. Pay attention to the translation of the verbs to follow, to influence, to watch, to affect in the passive form:

1) the pattern is influenced (was influenced, is being influenced, will be influenced);

2) the report was followed (has been followed, will have been followed, was being followed);

3) the experiments were watched (are being watched, will be watched, had been watched);

4) the results are affected (were being affected, have been affected, will have been affected).

VIII. Give the Russian equivalents of the sentences below. Pay attention to the translation of the predicates in the passive form.

1. This paper was shortly followed by another one by the same author. 2. The first question is readily answered. 3. There are circuits which are not influenced by

the temperature. 4. The rates and molecular weights are affected by lowering the temperature. 5. The experiment will be followed by testing the end product. 6. The level of oxygen is constantly watched by the operator. 7. Every thing is affected by its relations to everything else. 8. Methods employed in solving a problem are strongly influenced by the research objective. 9. The reaction was followed by measuring temperature. 10. The question arises as to how the behaviour of metals is affected by the changes in temperature.

READING 3

I. Read the title of the text and name its main theme.

MODERN TRENDS IN ELECTRONICS

The era of electronics began with the invention of the transistor in 1947 and silicon-based semiconductor technology. Seven decades later, we are surrounded by electronic devices and, much as we try to deny it, we rely on them in our everyday lives. The performance of silicon-based devices has improved rapidly in the past few decades, mostly due to novel processing and patterning technologies, while nanotechnology has allowed for miniaturization and cost reduction. For many years silicon remained the only option in electronics. But recent developments in materials-engineering and nanotechnology have introduced new pathways for electronics. While traditional silicon electronics will remain the main focus, alternative trends are emerging.

2D electronics

Interest in the field started with the discovery of graphene, a structural variant of carbon. Graphene is the strongest material ever tested.

In 2010, the Royal Swedish Academy of Sciences decided to award the Nobel Prize in Physics to Andre Geim and Konstantin Novoselov for their «groundbreaking experiments» in graphene research.

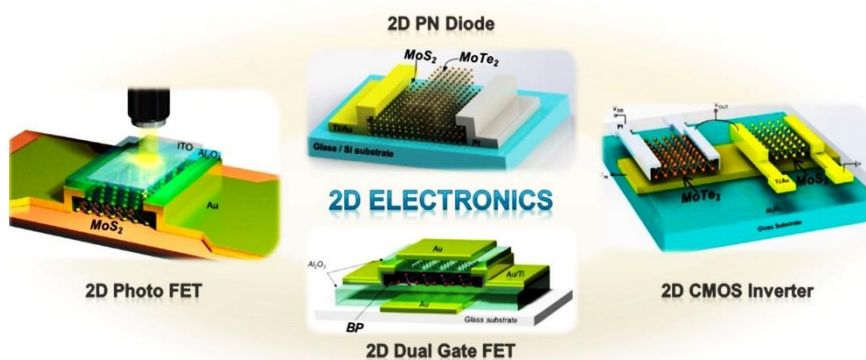

2D Material Devices

Graphene may have started this 2D revolution in electronics, but silicene, phosphorene and stanene, atom-thick allotropes of silicon, phosphorus and tin, respectively, have a similar honeycomb

structure with different properties, resulting in different applications.

All four have the potential to change electronics as we know it, allowing for miniaturization, higher performance and cost reduction.

Organic electronics

The development of conducting polymers and their applications resulted in another Nobel prize in 2000, this time in chemistry. Alan J. Heeger, Alan G. MacDiarmid and Hideki Shirakawa proved that plastic can conduct electricity.

Unlike conventional inorganic conductors and semiconductors, organic electronic materials are constructed from organic (carbon-based) molecules or polymers using chemical synthesis. Organic electronics is not limited to conducting polymers, but includes other organic materials that might be of use in electronics.

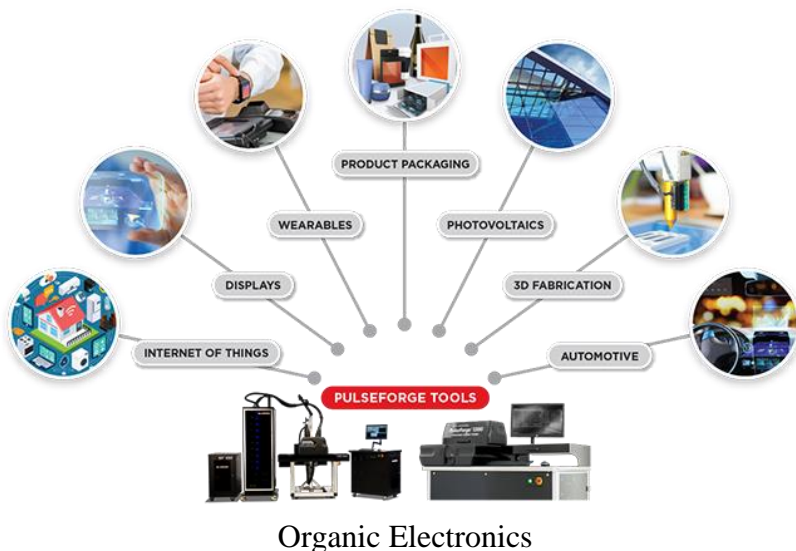

Commercially available high-tech products relying on organic semiconductors, such as curved television screens, displays for smartphones, coloured light sources and portable solar cells, demonstrate the industrial maturity of organic electronics.

Memristors

In 1971 Leon Chua reasoned from symmetry arguments that there should be a fourth fundamental electronic circuit-board element (in addition to the resistor, capacitor and inductor) which he called memristor, a portmanteau of the words memory and resistor. Many researchers believe that memristors could end electronics as we know it and begin a new era of «ionics».

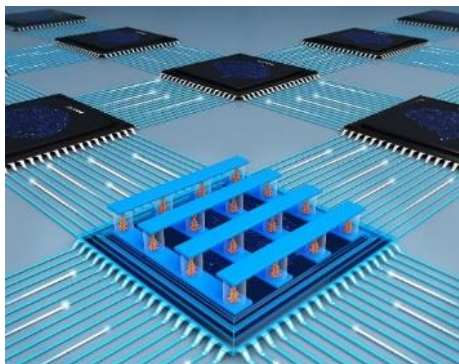

The schematic of multiple memristor-crossbar chips working jointly

The discovery of memristors paves the way to better information storage, making novel memory devices faster, safer and more efficient. There will be no information loss, even if the power is off. Memristor-based circuits will allow us to switch computers on and off instantly, and start work straight away.

For the past several years, Hewlett Packard has been working on a new type of computer based on memristor technology.

Spintronics

Spintronics, a portmanteau word meaning «spin transport electronics», is the use of a fundamental property of particles known as «electron spin» for information

processing. Electron spin can be detected as a magnetic field with one of two orientations: up and down. Carrying information in both the charge and spin of an electron potentially offers devices with a greater diversity of functionality.

Spintronic technology has been tested in information-storage devices, such as hard drives and spin-based transistors. Spintronics technology also shows promise for digital electronics in general.

It is expected that spin transport electronic devices will be smaller, more versatile and more robust compared with their silicon counterparts.

(<https://www.weforum.org/agenda/2015/08/5-next-trends-in-electronics>)

Note:

Portmanteau word is a new word formed by joining two others and combining their meanings.

II. Look through the first passage. What is the aim of it?

III. Define which of the following questions are answered in the text.

1. Why is silicon a widely used semiconductor material?
2. What are the opportunities and limitations of 2D electronics?
3. What is the essence of organic electronics?
4. What is the difference between resistors and memristors?
5. What does the word spintronics mean?

IV. In pairs, discuss what materials are used in 2D electronics and organic electronics. What do you know about their properties?

V. Find the information which helps you to explain how the names «memristor» and «spintronics» were coined. Give your own idea why 2D electronics and organic electronics got these names.

VI. Using the information from the text and given diagrams name possible fields of application of organic electronics and spintronic technology.

VII. In the text find the information characterizing the advantages of each technology. Share this information with your groupmates.

VIII. You are going to take part in a scientific conference. Your theme is «Modern Trends in Electronics». Give the main points of your report in 5-6 sentences.

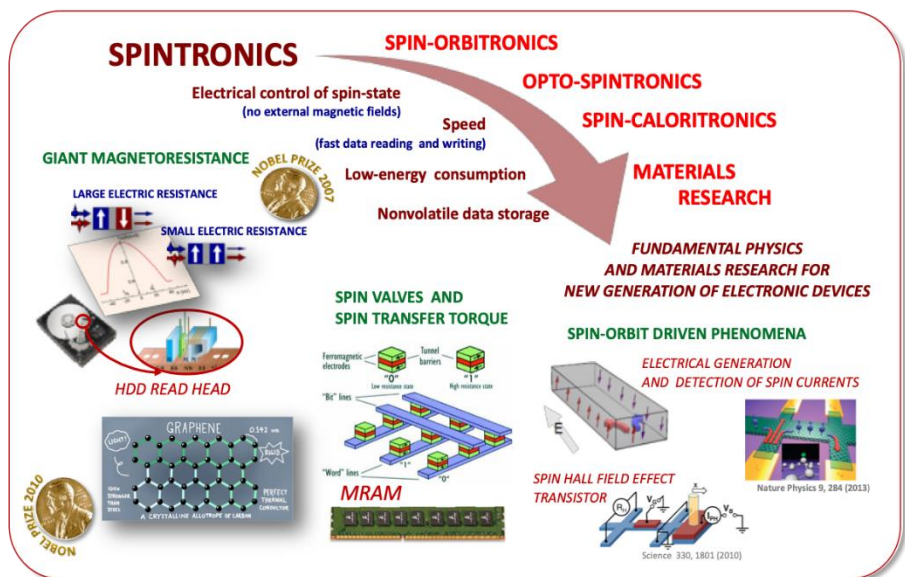

Spintronics applications

VIDEO

«MOLECULAR ELECTRONICS»,
2:11

(<https://www.youtube.com/watch?v=Z7OQ0SgPGUo&t=16s>)

I. Before watching the video complete the word combinations below by matching a word from A with a word from B.

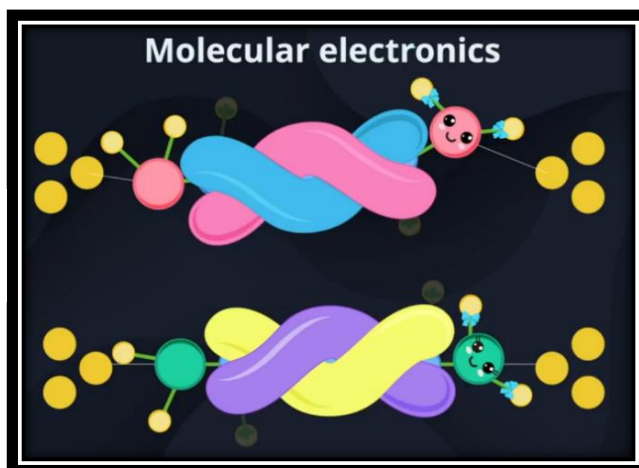

A	B
1) to shrink	a) attention
2) to gain	b) the technology
3) spatial	c) orbital
4) to harness	d) realm
5) quantum	e) the size
6) helical	f) orientation

II. Watch the video and answer the question: What are the advantages of molecular electronics?

III. Watch the video again and define the following statements as true (T) or false (F). Correct the false ones.

1. Technological breakthroughs are based on the properties of particles' interaction.

2. It is easy to harness the technology of quantum realm.

3. Helical orbitals are the result of the quantum mechanical features of a family of di-substituted silicon chains use.

4. The spheres, where the molecules that form the primary building blocks used, are limited today.

5. Carbyne is a material which has been known for a long time.

IV. Complete the sentences with the right option.

a) structure and orientation	b) spatial orbital	c) stable structures
d) structural composition	e) double bonds	f) circular manner

1. The decrease of electronic devices is restricted by the size of their _____.

2. Single molecules form the smallest _____ that can make possible the shrinking of electrical circuits.

3. The striking characteristics of long carbon chains depend on cumulative _____.

4. Molecular bonding is controlled by _____ orientation.

5. Current in molecules traveled in a _____ and its direction depended on the coiling of the orbitals.

6. The current flow could be directed by the _____ of the molecules.

V. Discuss these questions with your partner. Justify your point of view.

1. Why is molecular electronics gaining attention of scientists?

2. What are the future prospects of molecular electronics?

VI. There is an idiom at the end of the video «to be a tail with a twist». What does it mean? Prove it using the information from the video.

SUMMARY WRITING

A **summary** is a short objective restatement (in your own words) of the main idea and key points of the article/text.

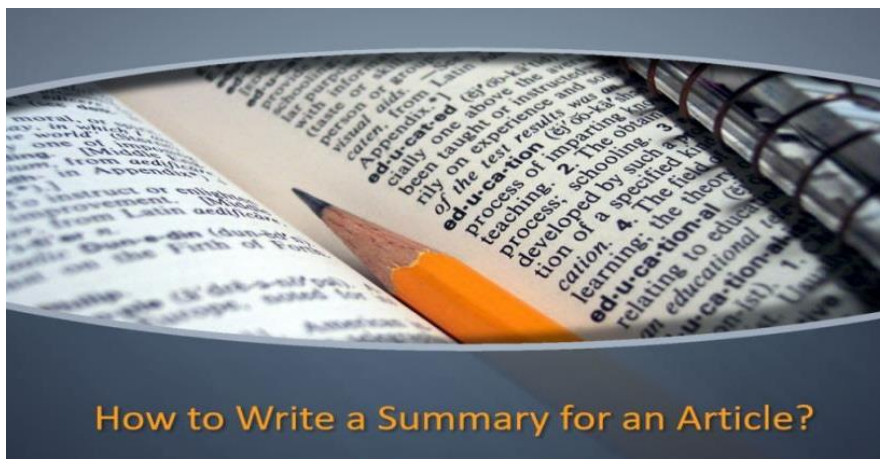

STEPS IN WRITING A SUMMARY

Step 1: Read the article

- to understand the article and define the main idea.

Step 2: Reread the article and make notes.

➤ Identify the MAIN points that the author is making to support the overall main idea of the article.

➤ Underline the most important details that support the main points.

➤ Divide the article into logical parts and make an outline: write down the main idea of each logical part in one well-developed **topic sentence**. Make sure that what you include in your sentences are key points, not minor details. Well-developed sentences are not necessarily long, but they are complete and tell the reader clearly what the idea is. Here, you need to be using your own words as much as possible and not copying from the original text.

➤ Write out key words and phrases to each part.

Step 3: Write the summary consulting your notes.

Your summary should include:

Introduction (1-2 sentences)

➤ Start with the title, the author, the source and the main theme/ idea of the article.

Body (1–3 sentences to each logical part)

- Start each main point with a **topic sentence**.
- Add the most important details from the article.

Final Point (1 sentence)

➤ The last sentence of your summary should be a concluding sentence that gives the summary a sense of closure. You might find a good sentence to paraphrase for this in the last paragraph of the reading.

Step 4: Check the summary against the article.

Finally, read through the article once more to ensure that:

- You've accurately represented the author's work.
- You haven't missed any essential information.
- The phrasing is not too similar to any sentences in the original.

What to do when writing a perfect summary:

- Present the ideas in the order in which they were discussed in the article.
- Put the ideas from the article into your own words. Avoid copying phrases and sentences from the article.
- Use transitional words and phrases to connect ideas (*see Scheme of a Summary*).
- Write the reporting verb in present tense.
- Include passive voice, if needed to emphasize objectivity.
- Revise for correctness in spelling, grammar, and sentence structure.

What to avoid when writing a summary:

- Repetition of similar ideas.
- Minor details (e.g., examples, descriptions, dates, numbers, statistics).
- Direct quotes (unless there is no other way to give the information). If you happen to use phrases or sentences directly from the text, make sure you use them in quotes.
- Digressions from the main points.
- Your own personal opinions or comments on the subject.
- Use of such bland, generic verbs like «say», «tell», «talk about», «write» (*see Reporting Verbs from «Scheme of a Summary»*).

SCHEME OF A SUMMARY

The points for rendering the article	Some expressions to be used while rendering the article																														
<p>Introduction</p> <p>➤ <i>the title, the author, the source, the date (on 2 May, XXXX)</i></p> <p>➤ <i>the main theme of the article</i></p>	<p>The article «<u>Title</u>» published on <u>date</u> in «<u>Source</u>» was written by <u>Name</u>.</p> <p>The title of the article written by <u>Name</u> is «<u>Title</u>» (<u>Source</u>, <u>date</u>).</p> <p>The article «<u>Title</u>» written by <u>Name</u> was published in «<u>Source</u>» (<u>date</u>).</p> <p>The article published in «<u>Source</u>» (<u>date</u>) head-lined «<u>Title</u>» was written by <u>Name</u>.</p>																														
	<p>It is devoted to/deals with/focuses on _____.</p> <p>The aim of the article is to provide the reader with some <i>material/data/facts</i> on _____.</p> <p>The main purpose of the article is</p> <table border="0" style="width: 100%; border-collapse: collapse;"> <tr> <td style="width: 70%; text-align: center; vertical-align: middle;"> <i>to give information about to <u>state</u> (see <u>Reporting verbs</u> below)</i> </td> <td style="width: 30%; text-align: center; vertical-align: middle;"> <i>the importance of the properties of the details of the role of the possibilities of</i> </td> </tr> </table>				<i>to give information about to <u>state</u> (see <u>Reporting verbs</u> below)</i>	<i>the importance of the properties of the details of the role of the possibilities of</i>																									
	<i>to give information about to <u>state</u> (see <u>Reporting verbs</u> below)</i>	<i>the importance of the properties of the details of the role of the possibilities of</i>																													
<p style="text-align: center;"><u>Reporting verbs</u></p> <table border="1" style="width: 100%; border-collapse: collapse;"> <tr> <td style="width: 25%;">argue</td> <td style="width: 25%;">state</td> <td style="width: 25%;">show</td> <td style="width: 25%;">recommend</td> </tr> <tr> <td>claim</td> <td>note</td> <td>demonstrate</td> <td>introduce</td> </tr> <tr> <td>insist on</td> <td>report</td> <td>illustrate</td> <td>underline</td> </tr> <tr> <td>define</td> <td>explain</td> <td>point out</td> <td>analyse</td> </tr> <tr> <td>highlight</td> <td>observe</td> <td>prove</td> <td>comment on</td> </tr> <tr> <td>study</td> <td>examine</td> <td>describe</td> <td>characterize</td> </tr> <tr> <td>propose</td> <td>suggest</td> <td>focus on</td> <td>emphasise</td> </tr> </table>				argue	state	show	recommend	claim	note	demonstrate	introduce	insist on	report	illustrate	underline	define	explain	point out	analyse	highlight	observe	prove	comment on	study	examine	describe	characterize	propose	suggest	focus on	emphasise
argue	state	show	recommend																												
claim	note	demonstrate	introduce																												
insist on	report	illustrate	underline																												
define	explain	point out	analyse																												
highlight	observe	prove	comment on																												
study	examine	describe	characterize																												
propose	suggest	focus on	emphasise																												
<p>Body</p> <p>➤ <i>the main points of the article</i></p>	<p>The article <i>begins with/opens with</i> the <i>description of/a review of/the analysis of/the characterization of/the explanation that</i> ____.</p> <p>Then (see <u>Transitional words</u> below) the author/the article gives a detailed <i>analysis/description</i> of ____.</p> <p>The author/The article gives valuable information on ____.</p> <p>It shows the advantages and disadvantages of ____.</p>																														
	<p>According to the article ____.</p> <p>It is reported ____.</p> <p>It is specially noted ____.</p> <p>Details are given of ____.</p> <p><i>Much/particular</i> attention is given to ____.</p> <p>It is expected that ____.</p>	<p>____ is/are discussed briefly.</p> <p>____ is/are proposed.</p> <p>____ is/are examined.</p> <p>____ is/are explained.</p> <p>____ is/are specially noted.</p> <p>____ is/are given in details.</p>																													

	It is pointed out that _____. Research has shown that _____. Experiments proved that ____.	
	<u>Transitional words and phrases</u>	
	Then Further on Next After that	In addition Furthermore Therefore Moreover
	Besides Also Thus However	On the contrary For example For instance As a result
Final Point ➤ <i>a conclusion drawn from the article</i>	To finish with , the author describes _____. At the end of the article the author draws the conclusion that _____. In conclusion the author _____.	

Study the following Summary Example.

SUMMARY EXAMPLE

«BEYOND THE FIVE SENSES» Matthew Hutson *Atlantic*, 2017
(found at www.theatlantic.com)

<p><i>In his July 2017 article in The Atlantic, «Beyond the Five Senses», Matthew Hutson explores ways in which potential technologies might expand our sensory perception of the world. He notes that some technologies, such as cochlear implants, are already accomplishing a version of this for people who do not have full access to one of the five senses. In much of the article, though, he seems more interested in how technology might expand the ways in which we sense things. Some of these technologies are based in senses that can be seen in nature, such as echolocation, and others seem more deeply rooted in science fiction. However, all of the examples he gives consider how adding new senses to the ones we already experience might change how we perceive the world around us.</i></p> <p>(https://pressbooks.ulib.csuohio.edu/csu-fyw-rhetoric/chapter/4-1-writing-summaries)</p>	<p>Introduction</p> <p>Body</p> <p>Final Point</p>
--	--

I. Read the article and define its main idea.

IBM's NEW CLIMATE-FRIENDLY CHIP

The world's first 2-nanometre chip could use 75 per cent less energy than those in use today

By Matthew Sparkes

IBM has built a working computer processor with 50 billion transistors in an area the size of a fingernail, making it the smallest and densest computer chip

architecture yet produced. If it is adopted for use in data centres and consumer electronics, it could slash the vast amount of energy required for computing.

The computer chip manufacturing industry names generations of chip technology by size class, though these don't refer to the actual size of the chip. New commercial devices tend to use 7-nanometre or 5-nanometre chips. For instance, Apple's M1 chip in its current range of computers and the A14 chip that powers current iPhones both use 5-nanometre chips.

IBM claims that it has created the first working 2-nanometre chip. The transistors in this prototype are 12 nanometres wide, which is just 24 silicon atoms across. Decreasing the size of transistors can make chips smaller, faster and more efficient, reducing their power needs.

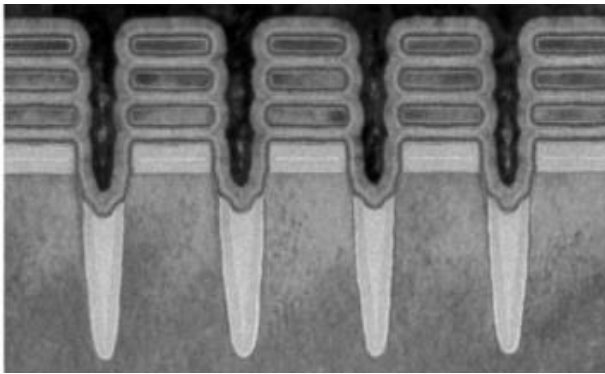

The new computer chip as viewed through an electron microscope

IBM says that 2-nanometre chips can be used in everything from phones and tablets to very high-performance server chips and supercomputers, and could achieve 45 per cent higher performance and 75 per cent lower energy use than the 7-nanometre chips in production today.

Steven Freear at the University of Leeds in the UK says that denser chips

would bring a range of benefits beyond power efficiency, including greater reliability due to the ability to improve security and error checking.

Mukesh Khare at IBM says the prototype chip was made at the company's headquarters in Albany, New York, and that the process involves «hundreds and thousands of steps» in a 9300-square-metre clean room that runs 24 hours a day.

IBM says that the chips will go into production in late 2024.

Chips as we know them today can be traced back to 1959 at Bell Laboratories in the US, where transistors were made by carefully oxidising a piece of silicon. The miniaturisation of chips is famously governed by Moore's Law, which states that the number of transistors on a processor will double every two years. This proved to be true for decades, but has slowed in recent years.

Kieran Brophy at Imperial College London says that improved chip design based on the transistor is rapidly approaching fundamental physical limits: «It's common knowledge that Moore's Law is breaking down. You fundamentally can't just keep going to smaller scales. You can't change physics».

Adoption of this technology could potentially help combat climate change by reducing the energy demands of the data centers that power email social media and video streaming services. Data centers like this currently account for 1 percent of the world's electricity use.

(New Scientist, 15 May 2021)

(<https://www.newscientist.com/article/2276858-ibms-minuscule-new-computer-chip-could-cut-energy-use-by-75-per-cent>)

II. Answer the questions.

1. What is the title of the article?
2. Where is the article taken from?
3. When was this article published?

4. Who is the author of it?
5. What kind of processor has IBM produced?
6. How are generations of chips technology classified?
7. Where will more dense chips be used and what are their benefits?
8. What have you learnt about Moore's Law?
9. How can the adoption of this new technology help the data centers?
10. What new information have you learnt from this article?

III. Divide the article into logical parts and make an outline of it. Write out key words and phrases revealing the content of each logical part.

IV. Write a short summary of the article using your outline and the SCHEME OF A SUMMARY given above.

FOLLOW UP

I. Work in groups to discuss the following quotes.



«Electronics are getting more and more accessible now – you don't have to be an engineer to start building things». *Simone Giertz*



«It's Moore's Law, everything will be obsolete in 10 years – I'll be obsolete in 10 years!» *Jerry Zucker*



«The microprocessor is a miracle». *Bill Gates*

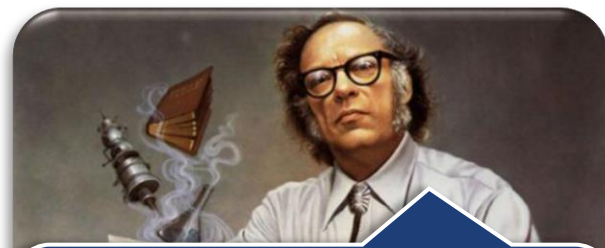

«The difference between electricity and electronics is the difference between a toaster and a television set». *Isaac Asimov*

II. Prepare a short presentation about a Nobel Prize Winner in the field of electronics.

III. A. Role play the following situation in pairs.

Student A

You are an interviewer. You are going to write an article «Electronics in Perspective». Ask a young scientist who is taking part in highly promising research in the field of electronics about his work in a research centre. Make up 10 questions about achievements, problems, future prospects.

Student B

You are a young scientist. You are working at a research center and are doing research in the highly promising sphere of electronics. Be ready to answer the interviewer's questions about your work. Think over your achievements, future prospects, problems.

B. Student A: Inform your groupmates about the main points of your article.

Student B: Give your predictions where the technology you are working on at your research center will be applied.

PART II

ELECTRONICS APPLICATION



«People are moving faster – you can see that in the streets. Partly that's because of the electronic devices, which encourage this».

Iain Sinclair

STARTING UP

I. Work in pairs. Read the definition below and name the device which is being described. Give your proofs.

a mechanical device an electronic device an electrical device a flotation device

It means an item that operates by controlling the flow of electrons or other electrically charged particles in circuits, using interconnections such as resistors, inductors, capacitors, diodes, switches, transistors, or integrated circuits and that enables access to or use of an electronic communication service, remote computing service, or location information service.

II. A. Look at the pictures and match these devices to their names. Do you know where these electronics are applied?

A smart TV-set	K dishwasher
B photo camera	L washing machine
C coffee machine	M sewing machine
D video camera	N book reader
E smart watch	O pulse oximeter
F computer	P arterial tonometer
G infrared thermometer	Q robotic vacuum cleaner
H sensor stove	R instant pot
I printer	S smartphone
J smart glasses	T microwave oven

 <https://learningapps.org/watch?v=phrwqiqt22>

B. Which of these electronic devices do you consider to be most useful? Give arguments why you think so.

III. Discuss the following questions in pairs and justify your point of view.

1. Do you agree that electronics is one of the greatest inventions?
2. What do you know about the electronics industry development?
3. Can you imagine your life without electronic devices? Why/Why not?

READING 1

I. Scan the text and choose the best title.

1. ROLE OF ELECTRONICS.
2. FIELDS OF ELECTRONICS APPLICATION.
3. ELECTRONIC DEVICES.
4. ELECTRONICS INDUSTRIES.

II. Five subtitles have been removed from the text. Choose from the subtitles given below (A–F) the one which fits each gap (1–5). There is one extra subtitle which you don't need to use.

- A. Production.
- B. Instrumentation.
- C. Home and Entertainment.
- D. Medical Services.
- E. Military Sphere.
- F. Information Transmission Sector.

III. Read the text and write out key words and phrases revealing the content of the text.

IV. The text is divided into logical parts. In each part find the topical sentence.

Using electronics today is so much a part of our daily lives we hardly think of the way the world would be without electronics. Everything from cooking to music uses electronics or electronic components in some way.

Electronics is conventionally classified into consumer, industrial, defence, communications and information processing sectors. In recent times, medical electronics, systems for transportation and power utilities have become important segments on their own.

1

Consumer electronics is the oldest sector of the field that began with the development of radio receivers after the invention of the triode. International competitiveness in this field requires constant innovation. This field has expanded remarkably in the last few years with the development of items such as compact disc (CD) players, digital audiotape, microwave ovens, washing machines, and satellite television reception systems. Consumer electronics are the electric devices meant for everyday use and categorized as office gadgets, home appliances, audio and video systems, advanced consumer devices and storage devices.

2

Industrial electronics is oriented towards manufacturing products required by modern industry-process control equipment, numerically controlled machinery and robots, and equipment for testing and measurement. This field of electronics refers to equipment, tools and processes that involve electrical equipment in an industrial setting. This could be a laboratory, automotive plant, power plant or construction site, etc. Industrial electronics are also extensively used in chemical processing plants, oil/gas/petroleum plants, mining and metal processing units, electronics and semiconductor manufacturing.

3

Advanced infrastructure in material sciences and sophisticated electronics are relevant for the defence field where cost is generally not a limiting factor. Equipment must be hardy enough to withstand environmental pressures, besides being precise and sensitive as well. Defence applications are completely controlled by electronic circuits. RADAR that is Radio Detection and Ranging is the most important development in an electronics field. Defence-electronics is strategic, it also has valuable spin-offs to offer industry. As well electronic devices and systems are intended to allow friendly forces to operate in hostile environments and to deny to hostile forces the effective use of electromagnetic resources.

4

Communications electronics (C-E) is a specialized and rapidly growing field concerning with the acquisition or acceptance, processing, storage, display, analysis, protection, disposition, and transfer of information. Electronic communication refers to any data, information, words, photos, emojis and symbols that are sent electronically. This can be done through emails, social media, newsgroups, chat rooms, video conferencing, instant messaging, phone and fax. To transfer and perceive data communications electronics includes the wide range of electronic devices and systems. Electronic sensors and sensory systems allow to acquire information. Communications equipment have immensely benefited from the development of efficient semiconductor lasers, optical fibre technology, digital techniques, and powerful microprocessors.

5

Electronics devices are being used in the health field, not only to assist in diagnosis and determination of medical problems, but to assist in the research that is providing treatment and cures for illnesses and even genetic anomalies. With the knowledge of electronics, many medical instruments are being developed for physiological analysis and data recording. Equipment such as MRI (Magnetic Resonance Imaging), CAT (Computerized Axial Tomography) and the older X-rays, tests for diabetes, cholesterol and other blood component tests all rely on electronics in order to do their work quickly and accurately. Pacemakers and similar equipment implanted in the body is now almost routine.

(<https://www.yourarticlelibrary.com/electronics/electronics-basic-facts-role-and-functions-of-electronic-devices/11179>)

https://www.streetdirectory.com/travel_guide/137712/electronics/electronic_world_how_we_use_electronics_in_daily_life.html

<https://www.quora.com/What-is-Industrial-electronics>

<https://en.wikipedia.org/wiki/Communications-electronics>

<https://intl.siyavula.com/read/cat/grade-10-cat/internet-communication/12-internet-communication>

Note:

spin-off (n) – unexpected but useful or valuable result of an activity.

V. Read the statements below and decide which of them correspond to the content of the text.

1. Electronics is widely used in our day-to-day life.
2. Electronics in our daily life are made up of active and passive electric elements and smaller integrated circuits.
3. New models of consumer electronic devices arise due to the international rivalry.
4. Electronically controlled systems are in use for heating and welding in industry.
5. Power stations that generate thousands of megawatts of electricity are controlled by tiny electronic devices and circuits.
6. Research and development carried out initially in the field of defence-electronics can also be widely applied in other industrial branches.
7. Electronics instruments such as cathode-ray oscilloscopes, frequency counters, signal generators, strain gauges are of great help in precise measurement of various quantities.
8. Research in the healthcare helping to diagnose disease is conducted by means of electronic devices.

VI. In the text find the facts containing the information on:

- a) types of consumer electronic devices;
- b) goods that industrial electronics is aimed to;
- c) requirements to military electronic devices and systems;
- d) a set of electronic tools (instruments) used for medical purposes.

VII. In the text find the information proving that:

1. The invention of the triode contributed greatly to the expansion of electronics in the consumption sphere.
2. The quality of manufactured products depends on the achievements in the field of electronics.
3. Communications electronics is a fast developing area of activity.
4. Data transmission is fulfilled by means of electronics.
5. Electronics application in medicine is one of the recent but very notable achievements for humanity.

VIII. Sum up the text using key words, word combinations and topical sentences.

IX. Express your attitude to the facts given in the text. Use the following phrases:

- To my mind _____.
- I find the text rather interesting/cognitive as/because _____.
- My view/opinion/belief/conviction is that _____.
- My impression is that _____.
- I hold the opinion that _____.
- Speaking personally, _____.

X. Say what information of the text is new to you. Do you find it useful? Express your opinion on the most promising field of electronics application.

GRAMMAR FOCUS 1

1.6. Сказуемое с модальными глаголами Predicates with Modal Verbs

1.6.1. Значение модальных глаголов

Модальные глаголы и их эквиваленты	Значение	Перевод	Примеры
1	2	3	4
may/might	возможность совершения действия, разрешение	<i>мочь, можно, разрешено</i>	You <i>may</i> get my location. Use this special database.
to be allowed to	разрешение	<i>можно, разрешено</i>	Our company <i>was allowed to</i> apply this technology.
can/could	возможность совершения действия, умение	<i>мочь, уметь</i>	Modern computers <i>can</i> multiply two numbers in one microsecond.
to be able to	способность совершения действия, умение	<i>мочь, быть способным/ в состоянии</i>	He <i>is able to</i> cope with the test of this device.
must	обязательность, неизбежность, необходимость выполнения действия	<i>обязан, должен</i>	The atom <i>must</i> be used for the good of mankind.
to have to (менее категоричный)		<i>должен, придется, вынужден</i>	The engineer <i>has to</i> examine this device.
to be to	обязательство; неизбежность, предопределенность действия; запланированность действия;	<i>обязан, должен; суждено</i>	We <i>are to</i> begin our experiment this week.
not to be to	запрет, невозможность действия	<i>нельзя, невозможно</i>	People <i>are not to</i> be in that area.

1	2	3	4
should	необходимость совершения действия (рекомендация или совет, целесообразность)	<i>должен, следует</i>	The engineers <i>should</i> carry out a new experiment.
ought to			The engineers <i>ought to</i> examine this device.
need	необходимость	<i>надо, нужно</i>	I <i>need</i> access all the services.
needn't	необязательность действия	<i>не нужно, вряд ли нужно</i>	You <i>needn't</i> transmit the image.

I. Compare the modal verbs below. Explain their differences.

Can – may; can – could; can – might; may – might; may – could; must – may; should – can; must – should; could – should; can – must; might – could; should – may; must – might; need – have to; needn't – shouldn't; is allowed to – is to; ought to – should; is not to – is not able to.

II. Define the meaning of the predicates with modal verbs.

Can solve; could solve; can be solved; could be solved; may obtain; might obtain; may be obtained; might be obtained; must find; must be found; should take; should be taken; can hold; could hold; can be held; could be held; may build; may be built; must heat; must be heated; should improve; should be improved; needn't transfer; need transfer; need be transferred; is to start; is to be started; is allowed to start; is allowed to be started.

III. In each pair of sentences below compare the predicates by form and meaning. Define their similarities and differences.

1. a) I can do research on semiconductors now. b) Electrons can be removed by the application of a very high electric field.

2. a) You may use carbon steel in the construction of this building. b) Electrons may be released from a gas in several different ways.

3. a) They could do research on copper alloys last term. b) Electronics could be defined as the study of the motion of electrons in, or the interaction of electrons with, a field of force.

4. a) An engineer must perform all the experiments according to the instructions. b) Students must not be late for their classes.

5. a) First, we should consider the arrangement of atoms in metals. b) It should be kept in mind that the initial electrons may be supplied by any of the methods discussed above.

IV. Give the Russian equivalents of the sentences below.

1. I want to become a materials engineer but I don't know what I must study.
2. You may apply alloy steels for various engineering purposes.
3. The engineers can use copper for electrical conductors.
4. The fields might be very complicated ones.
5. Matter may exist in any of its states: solid, liquid, gaseous.
6. This device cannot be

repaired today. 7. Scientists could not discover the secret of the atom for a long time. 8. You should use these devices in your research work. 9. Chemists must create the materials which don't exist in nature. 10. This equipment can work with high accuracy. 11. The testing is to start in 20 minutes. 12. This experiment was to become the most successful. 13. You needn't carry out this experiment until you are ready. 14. Your group ought to continue the test of this model. Its results can be satisfactory. 15. He was able to explain the principle of this gadget work. 16. The scientists are allowed to stay in this laboratory in protective suits. 17. This program isn't to be running, it's a computer virus.

WORD FORMATION

I. Explain the way of the word formation of the verbs below. Give their Russian equivalents.

Change, communicate, strengthen, redirect, darken, miscarry, differentiate, unfix, humanize, rearrange, interact, dislocate, miscalculate, replace, popularize, radioactivate, improve, worsen, preload.

II. Define which of the words in bold type are verbs. Give the Russian equivalents of the sentences with these verbs.

1. You **access** this information through one interface or tool called a Web browser.
2. With voice and language recognition we will have easy **access** to all that the Internet can provide.
3. One of the most recent **results** was the creation of a new discipline, mathematical logic.
4. Such a process **results** in changes in the end product.
5. The Internet **linked** computers and computer networks around the world.
6. Larger networks of computers **linked** together become now available.
7. The main **concern** of an engineer is the rate at which work is being done.
8. The articles **concern** the contribution of the Russian mathematicians to the theory of probability.
9. The investigations of the problem showed that his **approach** to it was misleading.
10. They **approach** this problem from many sides.

III. Use the correct form of the words given in parentheses according to the rule of word formation.

1. We can (**category**) consumer electronics as office gadgets, home appliances, audio and video systems, advanced consumer devices and storage devices. 2. We should (**connect**) him from our data warehouse. 3. Consult a service engineer otherwise you can (**apply**) and damage this tool. 4. Mobile or cellular phones were introduced with the main purpose to (**facile**) an immediate communication. 5. Many of us may fail to (**real**) the important role of electronics in our daily lives. 6. They have to (**charge**) batteries before using for the first time. 7. Algorithms are developed to (**extract**) 3D

information from 2D patterns. 8. Massive surge of power is able to **(load)** the system and blow out the lights. 9. You ought to **(house)** this item in black or dark casing. 10. If you have upgraded a running service, you shouldn't forget to **(start)** it.

WORD STUDY

I. Match the words to their definitions.

- | | |
|--------------------------------------|--|
| 1) software, <i>noun</i> | a) a program used to compose, edit, format and print documents; |
| 2) hardware, <i>noun</i> | b) a place where power or information leaves a system; |
| 3) computer, <i>noun</i> | c) to find or extract information stored in a computer; |
| 4) input, <i>noun</i> | d) operated by means of one or more electric accumulators; |
| 5) output, <i>noun</i> | e) a machine or device that performs processes, calculations and operations based on instructions which are provided by a software or hardware program. It has the ability to accept data (input), process it, and then produce outputs; |
| 6) retrieve, <i>verb</i> | f) programs or instructions used to tell a computer what to do; |
| 7) design, <i>verb</i> | g) to transmit or receive data, especially video and audio, over the Internet as a steady, continuous flow; |
| 8) battery-powered, <i>adjective</i> | h) machines, system of wires and other physical components of a computer or other electronic system; |
| 9) stream, <i>verb</i> | i) a place where, or a device through which, energy or information enters a system; |
| 10) word processor, <i>noun</i> | j) to create, execute, or construct according to a plan. |

II. Match the words to the ones with a similar meaning.

- | | |
|------------------|-------------------------|
| 1) to browse | a) to process, to treat |
| 2) data | b) to take out |
| 3) peripheral | c) movable |
| 4) to manipulate | d) to read, to scan |
| 5) to withdraw | e) to correct |
| 6) to enable | f) information, facts |
| 7) portable | g) form |
| 8) spreadsheet | h) to allow, to permit |
| 9) to edit | i) external, outside |
| 10) shape | j) electronic table |

III. Arrange the words from the first column to the suitable ones from the second column to get a word combination.

- | | |
|-------------------|-----------------|
| 1) editing | a) programs |
| 2) research | b) one task |
| 3) embedded | c) power |
| 4) numerical | d) capabilities |
| 5) to dedicate to | e) storage |
| 6) digital | f) laboratories |
| 7) compile | g) calculations |
| 8) data | h) processor |
| 9) storage | i) computer |
| 10) computational | j) spreadsheets |

IV. Fill in the gaps with the words given in the box.

a) operations	b) memory	c) perform	d) processing	e) information
f) peripheral	g) unit	h) external	i) devices	j) microprocessor

Conventionally, a modern computer consists of at least one **1.** _____ element, typically a central processing **2.** _____ (CPU) in the form of a **3.** _____, along with some type of computer **4.** _____, typically semiconductor memory chips. The processing element carries out arithmetic and logical **5.** _____, and a sequencing and control unit can change the order of operations in response to stored **6.** _____. **7.** _____ devices include input **8.** _____ (keyboards, mice, joystick, etc.), output devices (monitor screens, printers, etc.), and input/output devices that **9.** _____ both functions. Peripheral devices allow information to be retrieved from an **10.** _____ source and they enable the result of operations to be saved and retrieved.

V. Choose the most suitable word or phrase in bold in each sentence.

1. Today a computer is defined as an automated electronic **tool/machinery**.
2. We can **characterize/analyse** a computer as a speedy, automated and accurate device.
3. An **electronic/electric** device manipulating data is called a computer.
4. Modern mainframes provide a high-**capacity/possibility** data storage for Internet servers.
5. Our team have to **compile/write** programs into a machine code.
6. Computer power is **raising/increasing** every year.
7. Computers perform many different **work/functions** in our daily lives.
8. Today's PCs are equipped with very **powerful/strong** microprocessors.
9. We use a computer to **reproduce/type** documents.

READING 2

I. Give the definition of a computer. Then read the text and check if you are right.

II. Read the text again and name the stages of the computer development.

EVOLUTION OF COMPUTERS

1. A computer once meant a person who did computations, but now the term almost universally refers to automated electronic machinery. This is an electronic device for manipulating (processing, storing, retrieving and displaying) information, or data. The first computers were used primarily for numerical calculations. However, as any information can be numerically encoded, people soon realized that computers are capable of general-purpose information processing. Today's computers are characterized by speed, automation, accuracy, data permanent storage, secrecy and agility, and versatility. The development of quantum computers handling a large number of calculations would be able to do even more complex tasks.

2. The things all computers have in common are hardware and software. The physical elements of a computer, its hardware, are generally divided into the central processing unit (CPU), main memory (or random-access memory, RAM), and peripherals. Software denotes programs running on computers and giving to the hardware instructions what and how to do. Initially software referred primarily to what now is called system software – an operating system – and the utility programs that come with it, such as those to compile (translate) programs into machine code and load them for execution. Examples of software include web browsers, games, and word processors. Everything you do on your computer: typing documents, sending email, editing or creating spreadsheets, presentations, and even videos, etc. will rely on both hardware and software.

3. Many people throughout history are credited with developing early prototypes that led to the modern computer. During World War II, the first programmable general-purpose electronic digital computer, the Electronic Numerical Integrator and Computer (ENIAC), was designed at the University of Pennsylvania. Computers have undergone a long process from a minicomputer and a mainframe through a microcomputer or a personal computer (PC) to a supercomputer and an embedded processor.

4. Although minicomputers date to the early 1950s, the term was introduced in the mid-1960s. Relatively small and inexpensive minicomputers were typically used in a single department of an organization and often dedicated to one task or shared by a small group. Minicomputers generally had limited computational power, but they had excellent compatibility with various laboratory and industrial devices for collecting and inputting data. During the 1950s and '60s expensive computers of increasing power were made. They



The First Mainframe (1960)

were used by major corporations and government research laboratories typically as the sole computer. These computers called mainframes were characterized by having (for their time) large storage capabilities, fast components, and powerful computational abilities. Because of their complex systems mainframes were operated by a staff of systems programmers. Such systems remain important today, though they are no longer the sole, or even primary, central computing resource of an organization, which will typically have hundreds or thousands of PCs. Now mainframes provide high-capacity data storage for Internet servers, or, through time-sharing techniques, they allow hundreds or thousands of users to run programs simultaneously. Because of their current role these computers are now called servers rather than mainframes.



Mainframe Computer

5. Next step in computer development was a microcomputer or PC using microprocessors. In this small computer a vacuum tube was replaced with discrete transistors. Early microcomputers had relatively limited storage and data-handling capabilities. Today PCs have the most powerful microprocessors and high-performance colour graphics potential. The extremely powerful computers of the day



Supercomputer

– supercomputers – are very expensive and their use is limited to high-priority computations for nuclear simulations and weather modeling, evolution of the cosmos, nuclear weapons and reactors, new chemical compounds (especially for pharmaceutical purposes), and cryptology. Today many of the computational techniques of early supercomputers are in common use in PCs. Another class of computer is the embedded

processor – small computers that use simple microprocessors to control electrical and mechanical functions. Embedded processors help to control aircraft and industrial automation, and they are common in automobiles and in both large and small household appliances.



The Embedded Computer System

6. Nowadays, computer technologies development became the trigger of their introducing in consumer electronic devices. Coming in many shapes and size they perform many different functions in our daily lives.

(<https://edu.gcfglobal.org/en/computerbasics/what-is-a-computer/1>
<https://www.britannica.com/technology/computer>)

III. Define the following statements as true (T) or false (F). Correct the false ones. Find proofs in the text.

1. An electronic machine that can handle data is called a computer.

2. All material parts of a computer making it operate refer to its software.
3. The main purpose of minicomputers was to collect and output data.
4. Today's minicomputers retain in their memory a large volume of information necessary for Internet users.
5. Due to its large storage capacities, high-speed constituents and powerful computing capability a mainframe was used by main business companies and state research laboratories as the sole computer.
6. A modern personal computer is equipped with a powerful microprocessor and vacuum tubes.
7. Supercomputers are intended for vitally important computations in the spheres of space exploration, weather gearing, coding, and many others.
8. Lots of computing methods applied in early supercomputers are also used in PCs.

IV. Complete the following sentences choosing the most suitable variant.

1. Fulfilling more complex tasks will become possible due to the _____.
 - a) research in the field of electronics;
 - b) advancement of quantum computers;
 - c) development of computational techniques.
2. To handle information quickly a computer must _____.
 - a) compile a program;
 - b) execute a program;
 - c) possess a system software.
3. The invention of the first digital computer dates back to _____.
 - a) the mid-1960s;
 - b) the early 1950s;
 - c) the first half of 1940s.
4. The first electronic computer was built to do _____.
 - a) digital computations;
 - b) industrial automation;
 - c) mechanical functions.
5. Organizations applied minicomputers for accomplishing _____.
 - a) data manipulation;
 - b) a single task;
 - c) complex calculations.

V. In passage 1 find the information proving that a computer is a sophisticated device.

VI. Read passage 2 and name the components without which the existence of the computer is impossible. Justify your point of view.

VII. Read passages 3 and 4 and answer the following questions.

1. Where was the first computer created? What was the name of this computer and its intended use?

2. When did first minicomputers emerge?
3. Where were minicomputers used?
4. What were the main features of early mainframes?
5. What is the actual function of mainframes?

VIII. In passages 4 and 5 find the words or word combinations that mean the following:

a cheap computing mini device, accumulating data, to be devoted to a problem, a single computing device, at the same time, the most important calculations, very effective, built-in.

IX. Translate passage 5 into Russian.

X. Make an outline of the text.

XI. Speak on:

1. Emergence of computers.
2. Evolution of computers.
3. Embedded processors.

GRAMMAR FOCUS 2

1.6.2. Модальные глаголы с перфектным инфинитивом Modal Verbs with Perfect Infinitive (Modal Perfect)

Perfect Infinitive = have + Participle II (-ed)

Модальная конструкция	Значение	Перевод	Примеры
1	2	3	4
may/might (менее категоричная форма) + <i>Perfect Infinitive</i>	предположение или неуверенность в произошедшем	<i>возможно, может быть</i>	Their research group may have reported progress in this field.
must + <i>Perfect Infinitive</i>	большая степень вероятности действия в прошлом, имеющего отношение к текущему моменту	<i>должно быть, вероятно</i>	He must have attended this conference. He prepared his report last month.
should + <i>Perfect Infinitive</i>	невыполненное необходимое действие	<i>следовало (бы), должен был</i>	Scientists should have run a preliminary test of the system.
ought to + <i>Perfect Infinitive</i>	упрек, порицание за невыполненное или выполненное не так действие	<i>(бы), надо было (бы)</i>	They ought to have made a map of its surroundings on the fly.

1	2	3	4
could + <i>Perfect Infinitive</i>	действие, которое могло бы произойти, но не состоялось	возможно, мог + инфинитив, но не сделал; мог бы + инфинитив, но не сделал	I could have forecast this result. (But I didn't forecast.)
can/could (менее категоричная форма) + <i>Perfect Infinitive</i> (при отрицании и вопросе в главном предложении)	сомнение в возможности совершения действия в прошлом, что мог/смог + инфинитив	I don't believe he could have done it. Do you think I could have forgotten about it?
can not/could not + <i>Perfect Infinitive</i>	уверенность в том, что действие точно не произошло	не может быть, чтобы + глагол в прошедшем времени/ не мог (не смог) + инфинитив	He can not have referred to these results. He doesn't know them. He couldn't have driven to the airport because his car had been stolen.
needn't + <i>Perfect Infinitive</i> need you ...? + <i>Perfect Infinitive</i>	сомнение в целесообразности действия, совершенного в прошлом	не нужно было + инфинитив; нужно было + инфинитив	He needn't have been present all the time. Need you have done it?

I. Define the meaning of the predicates with Modal Perfect.

May have transmitted; might have been transmitted; needn't have carried out; can't have forecast; could have protected; must have performed; should have been designed; could have been connected; should have tested; need ... have raised; ought to have been extracted; must have been run; couldn't have been compiled.

II. Compare the predicates with modal verbs below. Explain their differences.

Can design – can have designed; can't design – can't have designed; ought to accept – ought to have accepted; should control – should have controlled; needn't decode – needn't have decoded; may be intercepted – may have been intercepted; is allowed to encode – might have encoded; has to be linked – must have been linked.

III. Give the Russian equivalents of the following sentences taking into consideration the forms and meanings of modal verbs.

1. The engineer might overlook something that may turn out to be important in carrying out this experiment. 2. You may have taken part in the research work. 3. All the calculations must be completed by next week. 4. All the calculations must have been completed long ago. 5. He needn't utilize the diffuser for his experiment. 6. He needn't have tested this tool 7. This device can't be used for a range of applications. 8. She can't have fixed the computer, it's still not working properly. 9. This application couldn't be improved. 10. The new equipment couldn't have been tested. 11. You should repair this device. 12. You should have changed the current strength at all points of the circuit. 13. You ought to conduct this experiment. 14. You ought to have completed the research in that field.

IV. Give the Russian equivalents of the following sentences, paying attention to Modal Perfect.

1. The data must have been lost. I don't see it anywhere. 2. I could have attended the conference, but I lost my invitation. 3. They ought to have given the necessary explanation. 4. They should have carried out the calculations. 5. One of the most interesting applications of these machines may have been in underwater work. 6. They needn't have tested new applications. 7. I don't believe he could have opened this file. 8. This method might have given good results. 9. Do you think that he could have taken part in the experiment? 10. This plant must have been put into operation long ago. 11. Need this scientist have been working on the computer in our laboratory? 12. He couldn't have broken the instrument during the experiment. 13. We can't have been content with the data available. These were not checked for viruses. 14. He should have known that the weight of a body is usually denoted by the letter «P». 15. I should have controlled this process. 16. His computer must have been protected because he installed an antivirus.

V. Give the Russian equivalents of the following sentences.

1. A slew of NFC smart rings is able to serve as a travel pass or ticket for public transportation with tap-to-pay card reader terminals at transit gates. 2. These chips can't have been used in supercomputers. 3. This program was to make the computer run. 4. The group of scientists at this research center might have carried out very interesting investigations. 5. He had to use the condenser for his experiment. 6. We ought to save time and reduce travelling costs by means of video conferencing through computers. 7. Your group should have connected people in various locations by means of PCs. 8. You are not to preinstall these applications. 9. The information can be quickly handled via the computer. 10. You need use an electronic arterial tonometer to measure the blood pressure.

READING 3

I. Read the title of the text and name its main theme.

CONSUMER ELECTRONICS

1. Consumer electronics are electronic (analog or digital) equipment intended for everyday use, typically in private homes. They include devices used for

entertainment, communications and recreation. Electronics are used in every work done by the human being: in eating and cooking food, in playing and monitoring health, in driving, in watching and many other things you will find the presence of electronics around you.

2. Nowadays, the mobile computing market is more confusing than ever. Laptops are battery-powered computers that are portable. Typically, a laptop weighs about five pounds and is about 1.5–2 inches thick, whereas a device referred to as a «notebook» is generally three pounds or less in weight and 0.5–1 inch in thickness. Notebooks and tablets are handheld computers more portable than laptops and small enough to be carried in a backpack or briefcase, which means a screen size of 15 inches or less. There are still other versions of the «book» computer. Netbooks are even smaller and are inexpensive devices meant for basic computing tasks such as word processing, email and web browsing, or tablets – that are even more portable than laptops. Instead of a keyboard and a mouse, tablets use a touch-sensitive screen for typing and navigation.

3. Many of today's electronics are basically specialized computers, though we don't always think of them that way. Here are a few common examples. Many cell phones can do a lot of things computers can do, including browsing the Internet and playing games. They are often called smartphones. When you withdraw cash from an ATM (Automatic Teller Machine), scan groceries at the store, or use a calculator, you are using a type of computer. Many people use desktop computers designed to be placed on a desk, and they are typically made up of a few different parts, including a computer case, a monitor, a keyboard, and a mouse. A game console is a specialized type of computer that is used for playing video games on your TV. Many TVs are Smart TV sets, very like the computer systems, that come with an operating system such as Google, Android and Tizen. Now it includes preinstalled applications, or apps, that let access various types of online content and allows to download and use several apps and games from the Net. For example, one can stream video from the Internet directly onto TV. The biggest thing is that the smart TV can be connected with other smart devices in the house and control them by means of apps on the smartphone.

4. Wearable technology is a general term for a group of devices – including fitness trackers and smartwatches – that are wearable computers in the form of a watch designed to be worn throughout the day. These devices are often called wearables for short. Fitness tracker is a device or application for monitoring and tracking fitness-related metrics such as distance walked or run, calorie consumption, and in some cases heartbeat. Modern smartwatches provide a local touchscreen interface for daily use and have more general functionality closer to smartphones, including mobile apps, a mobile operating system and Wi-Fi/Bluetooth connectivity. Some smartwatches function as portable media players, with FM radio and playback of digital audio and video files via a Bluetooth headset. Some models, called watch phones (or vice versa), have mobile cellular functionality like making calls.

5. It's impossible to imagine our lives without home devices and kitchen appliances. Microwave ovens, electric stoves and induction cookers are just using the electronics for generating the heat and cooking food. They have on board touch panel to set the temperature and various other parameters while cooking. Chimneys are used to avoid the smoke created during cooking. Robotic vacuum cleaners have a limited vacuum floor cleaning system combined with sensors and robotic drives with programmable controllers and cleaning routines. Washing machines and dishwashers equipped with electronics help to cope with household chores and make human life easier.



6. The world is changing and so is the technology with it. Man is now able to monitor his health by wearing a small belt on his wrist or by just through the small phones. They display the full health report that includes details regarding calories and fats. Electronic arterial tonometers enable to measure the blood pressure. Pulse oximeters provide a non-invasive measurement of the arterial oxygen saturation and the heart rate (pulse rate).

<https://edu.gcfglobal.org/en/computerbasics/what-is-a-computer/>

<https://en.wikipedia.org/wiki/Smartwatch>

https://en.wikipedia.org/wiki/Activity_tracker

<https://www.thebalancesmb.com/before-you-buy-a-laptop-or-notebook-computer-2946956>

<https://economictimes.indiatimes.com/news/how-to/how-to-select-the-right-tv-for-your-home/articleshow/86682990.cms?from=mdr>

II. Look through the first passage. What is the aim of it?

III. Define which of the following questions are answered in the text.

1. What is the difference between notebooks and laptops?
2. Which operating systems can laptop/notebook buyers choose?
3. What electronics products can also perform computer functions?
4. What equipment allows smartwatches to work as portable media players?
5. What space is necessary for a TV with a large screen?
6. What purpose do HDMI and USB ports of a Smart TV-set serve for?

IV. A. Compare the features of laptops, notebooks, tablets and netbooks by filling in the table below.

Laptop	Notebook	Tablet	Netbook

B. Explain their basic differences and present this information to your groupmates. Which of these computing devices do you have or would you like to buy? Give your arguments.

V. In the text find the definition of wearable technology. Name wearables that are trendy now and explain the reasons for their popularity.

VI. Find the passage containing the information on domestic electronics. Say which of these devices you have at home and whether you are satisfied with their work. What appliances would you like to buy and what for?

VII. You are going to move to another city as you have been offered a new job position of software engineer in an international company. Before relocating you will have to sell your house furnished with modern furniture and equipped with technological novelties. Show your house to a potential owner. Convince him to buy it with all consumer electronics you have making emphasis on the latest technology used in these devices. Give the main points of your presentation in 5-6 sentences. Use the information from the text you've read.

VIDEO

«WHAT IS WEARABLE TECH AND WHAT CAN I DO WITH IT»,
1:25

(<https://www.youtube.com/watch?v=hrLX8Woiak8>)



I. Before watching the video study the words that can help you to understand the speaker. Match each English word with its definition.

- | | |
|-----------------|---|
| 1) sci-fi | a) to keep track of smth. for a special purpose |
| 2) futuristic | b) an item that can be worn |
| 3) accessories | c) to send by means of electronic equipment |
| 4) to dim | d) to identify or to determine smth. |
| 5) wearable (n) | e) an imagined story about the future based on scientific knowledge |
| 6) to recognize | f) ahead of the time |
| 7) to monitor | g) to make smth. less bright |
| 8) to beam | h) supplementary smart electronic devices |

II. Match the words from the first column to the suitable ones from the second column to get a word combination.

- | | |
|------------------|----------------------|
| 1) to tap | a) hologram |
| 2) to teleport | b) smart glasses |
| 3) projective | c) the lights |
| 4) sci-fi | d) a badge |
| 5) to activate | e) on contact lenses |
| 6) to dim | f) levels |
| 7) to work | g) to another world |
| 8) blood glucose | h) accessories |

III. Watch the video and answer the question: What is the intended use of wearable electronics?

IV. Define the following statements as true (T) or false (F). Correct the false ones. Justify your point of view.

1. The fact that we can press the button and be transported across space and distance in no time doesn't seem so much unreal today.
2. People can use bangles to receive messages and calls.
3. The Google's new invention gives the possibility to identify the words inscribed in the air.
4. Users are able to switch on or make their devices work by means of the magic electronic ring.
5. The developers design devices worn on the human body for entertainment only.

V. Watch the video again and complete the sentences with the right option.

Call to mind super fancy **1.** _____ movies. It's enough to tap a **2.** _____ on the watch to teleport to another space. **3.** _____ things have become reality. You can actually get some of those sci-fi **4.** _____ like smart bracelets, rings, watches and even **5.** _____. They are called **6.** _____. Bracelets connected to your smartphone **7.** _____ incoming messages or calls. Words «Ok, Glass» **8.** _____ smart glasses created by Google. Rings can **9.** _____ what is written in thin air. Scientists are working on **10.** _____ that monitor blood glucose levels in your eye to diagnose diabetes. Soon you can **11.** _____ yourself to another planet.

VI. Discuss these questions with your partner.

1. What sci-fi accessories are mentioned in this video?
2. What is a new fabulous wearable devised by Google?
3. What do you think about wearables and their role in people's lives?
4. Have you tried Google glasses or a smart ring? If yes, share your impressions with the groupmates.

SUMMARY WRITING

I. Read the article and define its main idea.

A NEW SMART RING PATENT FROM GOOGLE HINTS OF USING THEIR SOLI RADAR TECHNOLOGY TO CONTROL MOBILE DEVICES WITH HAND GESTURES

By Jack Purcher

On August 16, Patently Apple posted a report titled «Google Joins the Race with Apple, Microsoft and Samsung to bring a Viable Smart Ring to Market after Amazon's Echo Loop Failed». One

week later and Google has been granted yet another wearables patent covering both a smart ring and smart glasses.

In this second granted patent, Google notes that their ring will be able to

harvest energy, and perhaps more importantly, detect hand gestures using a sensor unit which would be included under component area #130 of patent. FIG. 10B illustrated below.

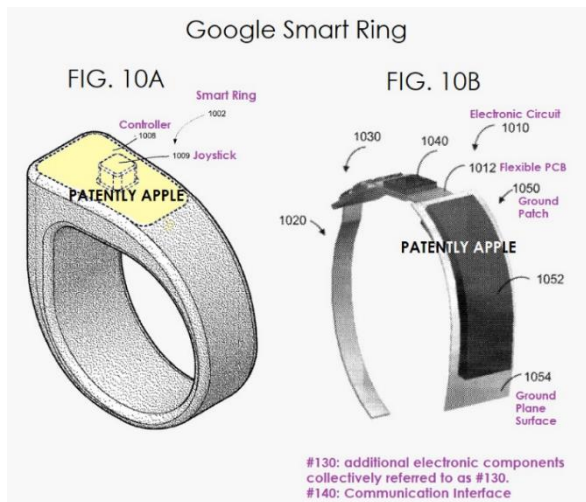

Why is hand gesturing important to this smart ring? Google introduced Soli Radar and motion sensing to the Pixel 4 but dropped in the Pixel 5. Google's SVP Devices and Services Rick Osterloh told The Verge that Project Soli radar and gestures would return in the future, that they were just too expensive for the phone that Google wanted to build.

Shifting Soli Radar to a smart ring would be one way to get around adding the technology to the phone directly. This way if a user wants this feature, he could have it via an added wearable device.

Google's granted patent is a «utility patent» and not a design patent. Google makes it clear that the ring could take on any number of final designs. The patent figures above only represent a concept.

Google's granted patent also covered Smartglasses as noted in the patent figures below. Google notes that «There is a need in the art for means to successfully integrate electronic components into smaller frames in order to achieve the inconspicuous form factor and fashion appeal expected of the eyeglass frame

industry while still maintaining a high display quality».

The original Google Glass device was conspicuous which made user a target for those protesting this kind of device that could inconspicuously film their surroundings and people without permission.

Google's patent FIG. 11 below is a perspective view of an exemplary implementation of a glasses frame formed; FIG. 12 is a perspective view of an exemplary implementation of a first arm of a glasses frame; FIG. 13A is a perspective view of an alternative exemplary implementation of a glasses frame formed.

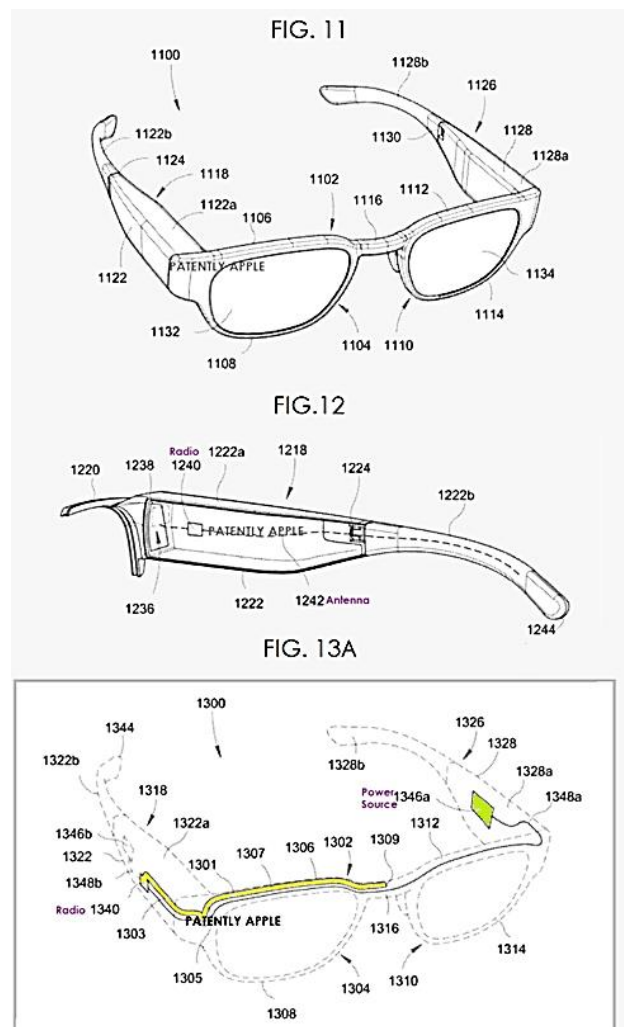

Google's granted patent 11,099,604 was issued on August 24, 2021. Without a doubt, smart glasses are going to be next

consumer device battle ground. Apple, Facebook, Microsoft, Amazon, Google, Samsung and Chinese OEMs are patenting and planning to participate in this wearable category.

Smart rings may be another consumer device that many OEMs are working on, but has less appeal due to the limited range of features of such a smart device. Smart rings could end up being a form of mobile mouse for Smartglasses and Google’s Soli radar may provide their ring with an advantage.

With that said, Apple is on record with the widest range of possible uses for smart rings as noted in the list of Apple patent reports presented below.

Apple’s counter punch to Soli radar is in the use of self-mixing interferometry

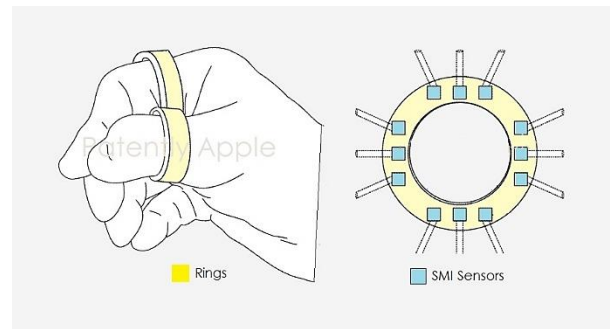

Apple Smart Ring

(SMI) sensors as described in the first patent presented below.

Relatively new brands are emerging with smart ring products that show different applications. One day an Apple ring could work with Apple Pay in retail stores and in transit stations as just two additional applications for those who don’t want an Apple Watch.

(Patently Apple, 29 August 2021)

(<https://www.patentlyapple.com/patently-apple/2021/08/a-new-smart-ring-patent-from-google-hints-of-using-their-soli-radar-technology-to-control-mobile-devices-with-hand-gestures.html>)

Note:

OEM – Original Equipment Manufacturer, an organization that makes devices from component parts bought from other organizations.

II. Answer the questions.

1. What is the title of the article?
2. Where is the article taken from?
3. When was this article published?
4. Who is the author of it?
5. What devices has Google patented?
6. Why do some people rebel against smart glasses?
7. What functions can Google’s smart ring perform?
8. What is the reason for electronic components integration into smaller frames?
9. Which companies have intentions to produce this type of wearable devices?
10. What opportunity could Apple ring users have one day if they don’t wear an Apple Watch?

III. Divide the article into logical parts and make an outline of it. Write out key words and phrases revealing the content of each logical part.

IV. Write a short summary of the article.

FOLLOW UP

I. Work in groups to discuss the following quotes.



«Dreams about the future are always filled with gadgets». *Neil de Grasse Tyson*



«I'm fascinated with the electronic devices that we can mess around with». *Gerry Mulligan*



«Consumer electronics is a challenging one». *Kevin B. Rollins*



«One of the most feared expressions in modern times is «The computer is down». *Norman Ralph Augustine*

II. A. Role play the following situation in pairs.

Student A

You are a young scientist. Your research team has designed the new model of a consumer device (e.g. a robotic vacuum cleaner, smart glasses, smart watches or biomedical devices, etc.) with the view of its coming into the market. A series of successful tests has been made. You will be interviewed for a popular scientific TV program. Prepare a presentation of your device highlighting its functions, features, performance and areas of application.

Student B

You are a TV journalist reporting about scientific and technological breakthroughs made by a research team. Brainstorm questions to interview a young scientist about his team achievements.

B. Inform your groupmates about scientific advances you've learnt about during the interview.

III. You have received an invitation to an international scientific conference devoted to the role of electronics in society. The themes discussed at all sections of the conference cover the main scientific directions:

- Basic concepts in electronics.
- The Third Industrial Revolution (The Digital Revolution).
- New trends on the electronics market.
- Computer applications in modern society.
- Flexible technology in consumer electronics.
- Electronic gadgets in the life of a modern individual.
- Challenges of medical electronics.

You've decided to participate in this conference and to make a presentation on one of the suggested themes. Think over the structure of your presentation, how to organize it clearly and guide listeners through the information.

The following tips and phrases might be helpful.

Action	Useful Phrases
1. Greet an audience	Good afternoon, everybody. I'd like to start by thanking you all for coming to my talk today.
2. Introduce yourself	My name is Max Stellman and I am a first-year student.
3. Present an outline of your talk	The theme of my talk today is _____. My purpose is to present, review _____.
4. Summarize the main points	To start with, I'll explain briefly _____. After that I'll describe/ consider/ analyze _____. Finally, I'll discuss/ I'll be considering/ I'll conclude by _____.
5. Invite listeners to ask questions	I plan to talk for about 10 minutes and at the end of the talk I'll answer all your questions. I'll be glad to answer any questions you have at the end of my presentation.
6. Express your thanks	Thank you for your attention.

MODULE 2 TELECOMMUNICATIONS

Grammar: THE EXTENSION OF THE SIMPLE SENTENCE AND ITS STRUCTURE

PART I NETWORKING



«An efficient telecommunications network is the foundation upon which an information society is built».

Talal Abu-Ghazaleh

STARTING UP

I. In pairs, discuss the following questions.

1. What is the meaning of the prefix «tele-» in the word telecommunications?

Can you complete the diagram and explain the meaning of each word?

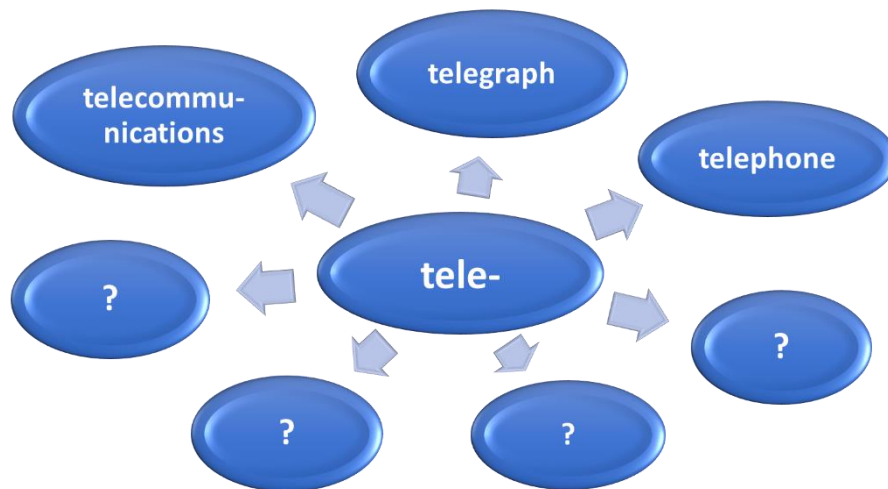

2. What is the role of telecommunications in modern life?
3. What achievements in the field of telecommunications do you use in everyday life?

II. How much do you know about telecommunications? Do the short quiz below.

1. What invention is Samuel Morse famous for?
A. television B. radio C. telegraph D. radar
2. Who invented the telephone?
A. Guglielmo Marconi B. Alexander Graham Bell C. Aleksandr Popov D. Nikola Tesla

3. When was television first established?
A. 1937 **B.** 1950 **C.** 1985 **D.** 1992
4. Who made the first mobile phone call?
A. Edwin Hubble **B.** Mark Zuckerberg **C.** Elon Musk **D.** Martin Cooper
5. Who is the inventor of WWW (World Wide Web)?
A. Tim Berners-Lee **B.** Bill Gates **C.** Steve Jobs **D.** Jeff Bezos
6. Which is the latest cellular/mobile generation currently in use?
A. 1G **B.** 2G **C.** 3G **D.** 4G and 5G

III. Check your answers using the QR-code or the link given below. Tell your partner some more facts you've learnt from the history of telecommunications.



<https://drive.google.com/file/d/1Si-xzhxpdmEoLvAEQFigUbbYR-m4vqbo/view?usp=sharing>

READING 1

I. Three headings have been removed from the text. Scan the text and choose from the headings A–E the one which fits each gap 1–3. There are two extra headings which you don't need to use.

- A.** Telecommunications Service Providers.
- B.** The Components of a Telecommunications System.
- C.** Interconnections among Networks.
- D.** Computer Network.
- E.** Telecommunications Systems.

II. Look through the text again and write out key words and phrases revealing the content of the text.

III. In each part of the text find the topical sentence.

1

Consider for a moment all the different communications that take place in an organization. Some communications are face to face, but others use some type of technology. Think of email, phone calls, text messaging, viewing pages on the Internet, downloading files. All of these communications make use of a telecommunications system. A telecommunications system is a collection of nodes and links to enable telecommunication. Telecommunication is communication at a distance using electrical signals or electromagnetic waves.

Examples of telecommunications systems are the telephone network, the radio broadcasting system, computer networks and the Internet. The nodes in the system are the devices we use to communicate with, such as a telephone or a computer.

In its most fundamental form, a telecommunications system includes a transmitter to take information and convert it to a signal, a transmission medium to carry the signal and a receiver to take the signal and convert it back into usable information. This applies to any communication system, whether it uses computers or not.

Most modern day telecommunications systems are best described in terms of a network. This includes the basic elements listed above but also the infrastructure and controls needed to support the system. There are six basic components to a telecommunications network.

1. Input and output devices, also referred to as «terminals».

These provide the starting and stopping points of all communication. A telephone is an example of a terminal. In computer networks, these devices are commonly referred to as «nodes» and consist of a computer and peripheral devices.

2. Telecommunication channels, which transmit and receive data.

This includes various types of cables and wireless radio frequencies.

3. Telecommunication processors, which provide a number of control and support functions.

For example, in many systems, data needs to be converted from analog to digital and back.

4. Control software, which is responsible for controlling the functionality and activities of the network.

5. Messages represent the actual data that is being transmitted.

In the case of a telephone network, the messages would consist of audio as well as data.

6. Protocols specify how each type of telecommunications systems handle the messages.

For example, GSM and 3G are protocols for mobile phone communications, and TCP/IP is a protocol for communications over the Internet.

While early telecommunications systems were built without computers, almost all systems we use today are computerized in some way.

A computer network is a system of computers and peripheral devices that are connected electronically. These connected computers can communicate with each other, which means that they can share information. Each computer has its own network address, so it can be uniquely identified among all the computers in a network. Computer networks are able to carry different types of data and support different applications.

Computers are connected using a number of different types of communication channels. These include both wired and wireless connections. Wired connections consist of an actual physical cable, such as copper wire or fiber optics. Wireless

connections do not use a physical cable but transfer data using waves at a particular part of the electromagnetic spectrum.

Why do we need a computer network? Transferring files between individual computers can be accomplished using physical media, such as DVDs or external hard drives but a computer network makes it possible to transfer data between computers without having to use physical media.

Some of the advantages of computer networks are:

- File sharing
- Internet connection sharing
- Sharing of peripheral devices
- Improved cost efficiency
- Increased storage capacity

The network itself can also carry out tasks that are difficult for any single computer to do. These network services have become increasingly important as many different types of devices are connected to each other.

(<https://study.com/academy/lesson/the-components-of-a-telecommunications-system.html>)

Notes:

- *TCP/IP* – Transmission Control Protocol/Internet Protocol;
- *GSM* – Global System for Mobile Communications.

IV. Read the statements below and decide which of them correspond to the content of the text. Give proofs.

1. Telecommunication uses electrical signals or electromagnetic waves to ensure communication over distances.

2. In a computer network nodes are devices such as a PC that together with peripherals make up a terminal equipment.

3. Telecommunication meets people's basic demands for communication and amusement.

4. Telecommunication channels provide transmission and reception of data.

5. At any station the transmitter and receiver may be combined into a single device called a transceiver.

6. Cellular and Internet communications require different set of rules called protocols.

V. In the text search for the information that explains:

- a) what a telecommunications system is;
- b) the key elements of a telecommunications network;
- c) the difference between the wired and wireless connections;
- d) why each computer should have its own network address.

VI. In the text find the reasons why computer networks are necessary and name their benefits.

VII. Sum up the text using key words, word combinations and topical sentences.

VIII. Express your attitude to the facts given in the text. Use the following phrases:

- I've found the text interesting/important/worth reading because _____.
- The information given in the text is of great value because _____.
- It seems significant to me that _____.
- I've learnt a lot about _____.
- I share the author's views on _____.

IX. Say what new information you have learnt about telecommunications systems. Do you think it can be useful in your future professional activities?

ADDITIONAL ACTIVITY

Complete the crossword puzzle using the clues given below.

CROSSWORD PUZZLE ON A TELECOMMUNICATIONS SYSTEM

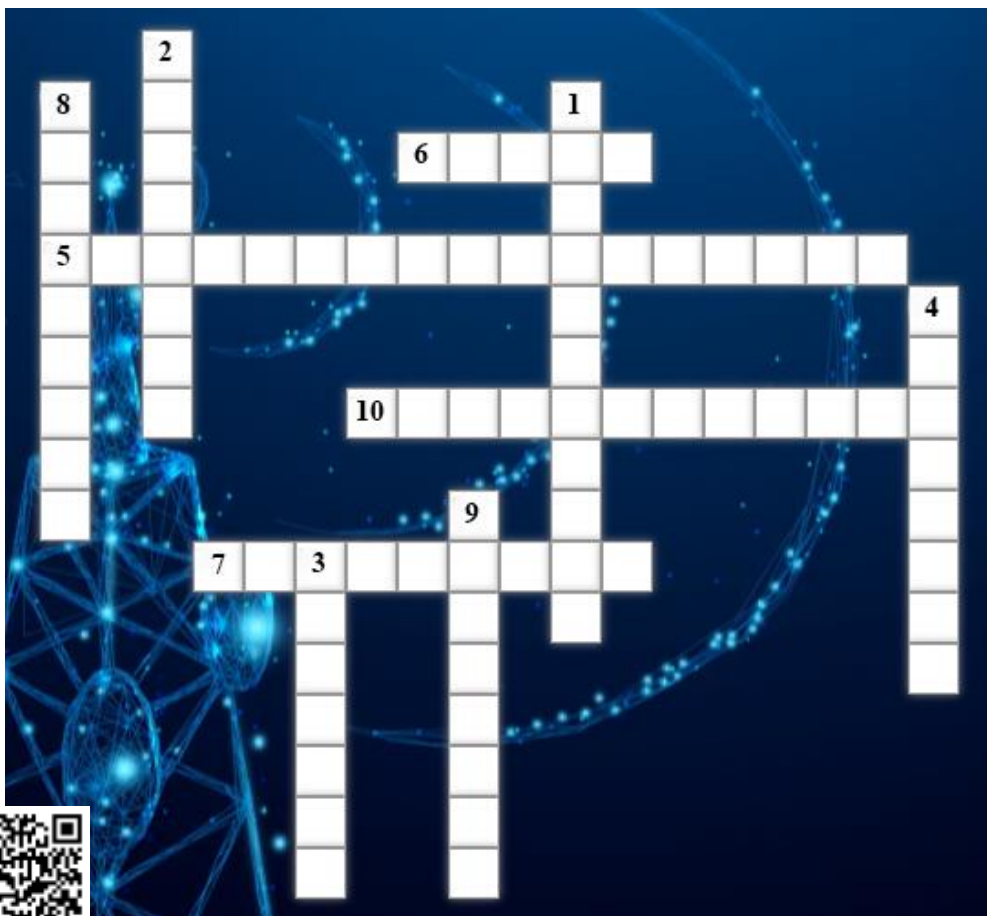

<https://learningapps.org/watch?v=pic5w5gi521>

Across	Down
<p>5. The branch of technology concerned with the transmission of information over a distance using electrical signals or electromagnetic waves.</p>	<p>1. It refers to how often the network does not perform as expected.</p> <p>2. The layout of the interconnections between the computers in a network is called _____.</p>

6. These are devices in a system that is attached to a network and are used for communication.

7. The data transfer rate or the maximum rate of data transferred over a network at a specified amount of time.

10. Computer networks are used to share information, carry different types of data and support different _____.

3. A control software is responsible for controlling the functionality and activities of the _____.

4. This refers to the actual data that is transmitted over a telecommunications network.

8. It plays an important role in communications systems because it sets the rules on how the messages are handled.

9. The type of connection does not require a physical cable but delivers data using waves.

GRAMMAR FOCUS 1

2.1. Основные составные элементы предложения (русско-английский вариант)

№ п/п	Русский вариант	Модельные слова	Функции составных элементов ¹ предложения	Английский вариант: (x – английское слово с дифференциальным признаком)
1.	Студент читает	Кто делает	с ск	The X X
2.	Студент читает книгу	Кто делает что	с ск о	The X X the X
3.	Студент читает интересную книгу	какую-то	ол	the x x
4.	Студент читает книгу друга	чего-то (кого-то)	ор	the x <i>of the x</i>
5.	Студент читает книгу давнего друга	какого-то	олр	the x <i>of the x x</i>
6.	Студент читает купленную книгу	сделанную (какую-то)	ппл	the <i>xed</i> x
7.	Сидящий студент читает книгу	делающий (какой-то)	пал	the <i>xing</i> x
8.	Студент внимательно читает книгу	как-то	н	<i>xly</i>
9.	Студент читает книгу у окна	у чего-то (на, в...)	дп	<i>at the x (on, in...)</i>

¹Составные элементы предложения: с – субъект, ск – сказуемое, о – объект, ол – определение левое, ор – определение родительное, олр – определение левое родительное, ппл – причастие пассивное левое, пал – причастие активное левое, н – наречие, дп – дополнение предложное.

I. Find points 3, 6, 7 in the table (English variant). Define their similarities and differences.

II. Find points 4, 5 (English variant). Define their similarity and difference.

2.2. Структура простого повествовательного предложения

1. Связь слов в повествовательном предложении определяется их **фиксированным местом в предложении относительно сказуемого**.
 2. Субъект и сказуемое являются обязательными членами предложения (кроме повелительного наклонения).

0 ¹ место	1 место	2 место	3 место	4 место
Дополнение предложное, наречие (где? когда? и т. п.)	Субъект или его группа ²	Сказуемое	Объект или его группа (дополнение)	Дополнение предложное, наречие ³ (где? когда? и т. п.)
ДП, Н	с	ск	о	ДП, Н

Определение⁴

In navigation	Radio radio	can ensure can ensure	greater safety greater safety.	in navigation.
---------------	-------------	--------------------------	-----------------------------------	----------------

III. Define the similarities and differences of the words in bold type, name their functions in the sentence.

1. You can't expect all this perfection to happen without a lot of **work**. 2. This **work** doesn't meet our requirements. 3. To meet such demands in practice scientists and engineers must **work** hard. 4. Only a handful of human minds can comprehend his **work**. 5. He was newly employed to **work** on innovative technologies. 6. Typically GPS units will not **work** indoors, underwater or underground. 7. How do these features **work** so well?

¹Место в предложении – слово или группа слов, связанных по смыслу.

²Субъектом будет первое существительное без предлога и не стоящее после неличной формы глагола.

With open source software, *programmers* contribute to the computing community by making their improvements.

Группа субъекта никогда не разделяется и состоит из левых и правых определений.

³*Группа дп, н* может находиться либо в начале предложения (нулевое, факультативное место), либо в конце предложения (4-е место). Наречие может стоять перед сказуемым (единичным) или после первого вспомогательного глагола.

Marconi *even* recognized the military importance of radar.

Some books may *never* be published in paper form.

⁴*Определение* не имеет постоянного места в структуре предложения, оно обычно входит в состав смысловой группы определяемого существительного, располагаясь слева и справа от него.

The web is made of *electronic* addresses *called* websites.

IV. Divide the sentences into sense groups. Define the dependency relations in each group. Give their Russian equivalents.

1. A comprehensive data security strategy incorporates people, processes and technologies. 2. Usability plays an important role at each stage of the design process. 3. Mobile devices can also be used as a control device. 4. The power consumption of mobile devices directly affects their usage time. 5. Computer network architecture defines the physical and logical framework of a computer network. 6. Any party with proper equipment can receive and send messages in the network. 7. Authentication protects the service provider from unauthorized intrusion.

2.3. Функции и значения местоимения it

<p>1. Личное местоимение в функции <i>субъекта</i> (подлежащего) при сказуемом в ед. ч. или в функции <i>объекта</i> (дополнения) = <i>он, она, оно; его, ее</i>. The telephone network is reliable because <i>it</i> uses its own wire system. The fiber-optic receiver performs the actual reception of the optical signal and converts <i>it</i> into electrical pulses.</p>
<p>2. Указательное местоимение в функции <i>субъекта</i> (подлежащего) при сказуемом в ед. ч. = <i>это</i>. <i>It</i> is an efficient means of interaction.</p>
<p>3. В функции <i>субъекта</i> (формального подлежащего) в <i>безличных</i> предложениях = <i>не переводится</i>. <i>It is difficult</i> to imagine modern life without the Internet.</p>
<p>4. В функции <i>объекта</i> (формального дополнения) после глаголов <i>to find, to make, to think</i> + <i>прилагательное</i> = <i>не переводится</i>. Radio electronics has made <i>it</i> possible to test various equipment.</p>
<p>5. В функции <i>коррелята</i> (вводного слова) в предложениях с эмфатической конструкцией <i>it is (was) ... that (who)</i> = <i>именно, только</i>. <i>It was</i> electronics <i>that</i> produced radar.</p>

V. Define the functions and meanings of the pronoun it. Give the Russian equivalents of the following sentences.

1. By reducing cognitive load you make *it* easier for visitors to grasp the idea behind the system. 2. *It* is not reasonable to force users to enter an email address just to test the feature of the service. 3. Content is more important than a design which supports *it*. 4. In a wireless environment *it* is possible to prevent the attacker from gaining valuable information. 5. *It* is a fundamental principle of successful user interface design. 6. *It* is the combination of protocols and infrastructure that tells information exactly where to go. 7. Without good wireless transmission *it* is very hard to obtain a reliable signal.

2.4. Функции и значения one

1. **One** + существительное – **числительное** = **один, одна, одно**.

There is only **one** solution to the problem.

2. В функции **субъекта** (формального подлежащего) при сказуемом с модальным глаголом в **неопределенно-личных предложениях** = **не переводится**.

One should pay attention to data security.

3. **Слово-заместитель** (one/ones) вышеупомянутого существительного. Переводится существительным, которое заменяет, или совсем не переводится. В этом случае перед **one/ones** стоит артикль **the**: **the one** = **mom, ma, mo**; **the ones** = **me**.

This method is **the one** which can be relied on.

VI. Define the functions and meanings of one. Give the Russian equivalents of the following sentences.

1. To secure wireless signals like WPA and WPA2, **one** must use strong security protocols. 2. In a fiber optic communication system we transmit information from **one** point to another **one** in the form of light signals and pulses. 3. The last experiments gave us much better results than did the previous **ones**. 4. Laser is **one** of the most sophisticated inventions of man. 5. **One** doesn't have to prepare a new program each time you set a new function to a microprocessor-equipped robot. 6. Open radio communication was **one** of the first wireless technologies to find widespread use. 7. **One** can roam around freely without worrying about the Internet connection and still stay connected. 8. Our world has become so various and complicated that we no longer have **one** common medium of communication. 9. The connections from desktop PC, or client, to the server are Internet connections, not wired **ones**.

2.5. Словосочетание как расширение субъекта, объекта, дополнения предложного, определения родительного

Именное словосочетание состоит из существительного-ядра и определений к нему:

а) левых – прилагательное (определение левое), причастие (причастие активное левое, причастие пассивное левое), герундий, существительное;

б) правых – определение родительное, существительное с предлогом (дополнение предложное), причастие пассивное (единичное), оборот.

Помните! Артикль и его заменители относятся к последнему слову-ядру.

Наиболее распространенными определителями имени существительного являются артикли a (an), the.

Заменители артикля

this – these, that – those

my – his – her – its – our – your – their

all – any – some – no

ЭТОТ – ЭТИ, ТОТ – ТЕ

МОЙ – ЕГО – ЕЕ – ЕГО(ЕЕ) – НАШ – ВАШ – ИХ

ВСЕ – ЛЮБОЙ – НЕКОТОРЫЙ – НИКАКОЙ

another – other, every – each
 many – much, more, most
 few – little, less, least
 very (the very), such

другой – другие, каждый – каждый
 многие – многое, более, наибольший
 немногие – немногое, менее, наименьший
 очень (тот самый), такой

VII. Name the features and functions of the constituent elements of word combinations below. Give their Russian equivalents.

- the **device**
- the small **device**
- the small electronic **device**
- the small electronic functioning **device**
- the designed **device**
- the small electronic newly designed **device**
- the **device** of the laboratory
- the **device** of the experimental laboratory
- the **device** of the experimental diagnostic laboratory
- the small electronic **device** of the experimental testing laboratory
- the small electronic functioning **device** of the recently created experimental diagnostic laboratory
- the small electronic newly designed **device** of the experimental diagnostic laboratory of the technological company

VIII. Give the Russian equivalents of the following word combinations.

Other solutions; these conditions; any attempt; some preventive measures; in a specific direction; by various means; with some significant differences; in the network layer; multiple points on the screen; for the systems aspects of security; the requirement for secure authentication; one of the main constraints on cryptography; hundreds of examples of security features in numerous industries.

2.6. Прилагательные и наречия

2.6.1. Признаки распознавания прилагательных и наречий

Прилагательное (какой?)	Наречие (как?)
<p>1. the <u>x</u> x¹ ↓ перед существительным (ол) <i>Wireless</i> data communications are an <i>essential</i> component of <i>mobile</i> computing.</p>	<p>1. <u>xly</u> ↓ поясняет глагол The decision was made <i>quickly</i>.</p>
<p>2. <u>x</u> ↓ часть составного именного сказуемого после глаголов <i>to be, to become, etc.</i></p>	<p>2. <u>xly</u> x x¹ ↓ перед прилагательным или другим наречием обозначает признак или степень качества</p>

We are <i>familiar</i> with the concept.	They are solving a <i>highly</i> important problem. These systems have been used <i>almost exclusively</i> by such experts for several reasons.
--	---

¹Существительное может выполнять функцию субъекта (с), объекта (о), дополнения с предлогом (дп), определения родительного (ор).

IX. In the following sentences find adjectives and adverbs, name their features and define their meanings.

1. With the rapid growth of the Internet there have been significant changes and improvements in online searching. 2. They include a broad and diverse existence of both information retrieval systems and various interfaces and functions. 3. Participants held neither highly positive nor highly negative perceptions about the Web of Science interface. 4. The systems have been used almost exclusively by the experts for several reasons. 5. Most security problems are intentionally caused by malicious people trying to gain some benefit, get attention or harm someone. 6. Network security problems can be divided roughly into four closely intertwined areas.

WORD FORMATION

I. Define which of the words below are adjectives. Give their Russian equivalents.

Precise; convert; crucial; receive; transmission; identify; connection; actual; transfer; optical; efficiency; conventional; capacity; complex; encryption; cognitive; improvement; powerful; accordingly; significant; require; application; multiple; connectivity; malicious; evaluation; scientific.

II. Explain the way of the word formation of the adjectives and adverbs below. Give their Russian equivalents.

a) flexible, accessible, compatible, responsible, invisible; b) usable, available, applicable, predictable, portable, vulnerable, valuable, detectable; c) fundamental, digital, principal, essential, external; d) refractive, inventive, sensitive, protective, innovative; e) rapidly, increasingly, simultaneously, entirely, consequently, frequently, relatively, accurately, barely.

III. Use the words given in capitals at the end of the sentences and the suffixes below to make new words and fill in the gaps.

-ment; -ty; -ous; -able; -ion; -ly

1. Temperature sensors used in _____ devices and smartphones also use a fiber optic technology.

WEAR

2. Another recent _____ in fiber cables is known as WDM, or wavelength division multiplexing.

IMPROVE

3. The most prominent advantage of a passive optical network is the _____ of the outdoor active devices.	ELIMINATE
4. Security and _____ are extremely important when it comes to cabling.	SAFE
5. An increase in Internet traffic would _____ pose a capacity problem and require more frequent cable upgrades.	OBVIOUS
6. Fiber optics now has several classifications in order to suit _____ conditions, cost and performance.	VARY
7. A splitter has many input and output terminals, especially _____ to a passive optical network.	APPLY

WORD STUDY

I. Match the words to the definitions.

1) network capacity	a) a channel by which information is transmitted between a sender and a receiver;
2) bridge, <i>noun</i>	b) amount of time a call spends waiting to be processed;
3) gateway, <i>noun</i>	c) an electrical or photonic (for fiber optic-based systems) communication path between two or more points of termination;
4) server, <i>noun</i>	d) the result of two devices on the same network attempting to transmit data at exactly the same time;
5) channel, <i>noun</i>	e) a network node that connects otherwise incompatible networks;
6) delay, <i>noun</i>	f) a networked computer that stores information and makes it available upon request to clients that may be located on other computers;
7) communication medium	g) the amount of traffic that a network can handle at any given time;
8) collision, <i>noun</i>	h) a device that connects and passes data packets between two network segments.

II. Match the words to the ones with a similar meaning.

1) scope	a) to change
2) significant	b) at the same time
3) to enable	c) adaptable
4) to convert	d) range
5) to detect	e) important
6) flexible	f) to appear
7) simultaneously	g) to allow
8) to emerge	h) to identify

III. Replace the words in bold with words/word combinations from the box with the same meaning.

a) numerous b) grown c) make better d) transmits e) unattainable f) linked

1. There are several technologies and practices that can **improve** data security.
2. Now we have access to new kinds of information previously **unavailable**.
3. In many cases a communication channel is shared by **multiple** users.
4. Nodes **connected** together in a wireless LAN may broadcast via radio or optical links.
5. A switched communication network **transfers** data from source to destination through a series of network nodes.
6. The speed of data transmission has **increased** with the invention of a digital technology.

IV. Choose the correct word to complete these sentences.

1. The LAN ports are used to connect computers that don't have Wi-Fi _____ using an Ethernet cable.
a) approach b) access c) entrance d) denial
2. In order to _____ from the Internet, like email or Web pages, every computer connected to the Internet needs an Internet Protocol address.
a) receiver b) reception c) recipient d) receive
3. Internet _____ and the ability to communicate between computers are based on a set of communication standards and protocols.
a) connectivity b) relativity c) sensitivity d) creativity
4. A digital system for telecommunications, called TI _____, is in wide use in parts of the telephone network.
a) courier b) career c) carrier d) carer
5. Recently, service _____ have been focusing on growing services, such as data and video, as opposed to voice communication services.
a) resource b) refusers c) providers d) supply
6. The transmission _____ determines the level of speed of the communication.
a) middle b) media c) broadcasters d) tools

READING 2

I. Read the text and name the common types of networks based on their geographical scope.

SCOPE OF NETWORKS

1. The scope of a network refers to its geographical size. A network can range in size from just a few computers in one office to thousands of computers linked together over great distances. Network scope is determined by the size of the organization or

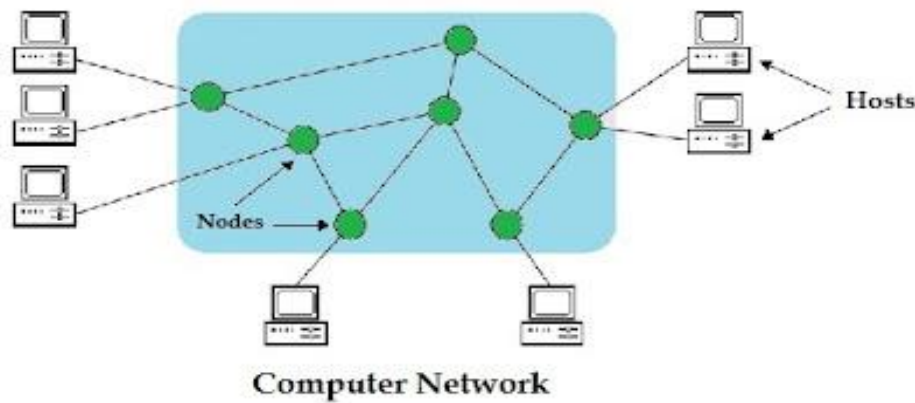

the distance between users on the network. The scope determines how the network is designed and what physical components are used in its construction. There are two general types of network scope:

- Local Area Networks (LANs)
- Wide Area Networks (WANs)

2. Local area networks (LANs) connect computers and peripheral devices within a building or small group of buildings by means of links (wires, Ethernet cables, fibre optics, Wi-Fi) that transmit data rapidly. A typical LAN consists of two or more personal computers, printers, and high-capacity disk-storage devices called file servers, which enable each computer on the network to access a common set of files. LAN operating system software, which interprets input and instructs networked devices, allows users to communicate with each other; share the printers and storage equipment; and simultaneously access centrally located processors, data, or programs (instruction sets).

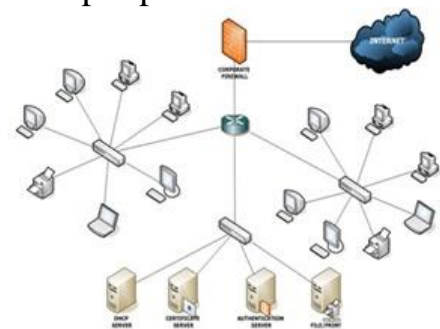

3. A LAN may be configured as (1) a bus, a main channel to which nodes or secondary channels are connected in a branching structure, (2) a ring, in which each computer is connected to two neighbouring computers to form a closed circuit, or (3) a star, in which each computer is linked directly to a central computer and only indirectly to one another.

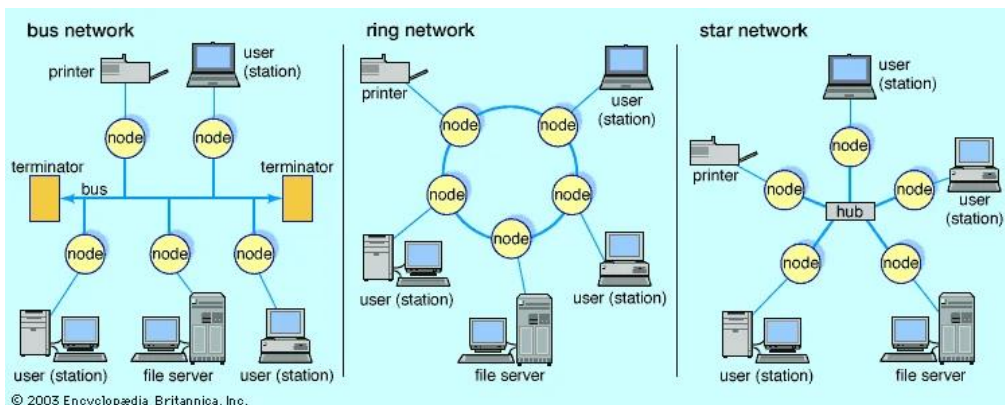

Each of these has advantages, though the bus configuration has become the most common.

LAN users may also access other LANs or tap into WANs. LANs with similar architectures are linked by «bridges», which act as transfer points. LANs with different architectures are linked by «gateways», which convert data as it passes between systems. Even if only two computers are connected, they must follow rules, or protocols, to communicate. For example, one might signal «ready to send» and wait

for the other to signal «ready to receive». When many computers share a network, the protocol might include a rule «talk only when it is your turn» or «do not talk when anyone else is talking». Protocols must also be designed to handle network errors.

4. The most common LAN design since the mid-1970s has been the bus-connected Ethernet, originally developed at Xerox PARC. Every computer or other device on an Ethernet has a unique 48-bit address. Any computer that wants to transmit listens for a carrier signal that indicates that a transmission is under way. If it detects none, it starts transmitting, sending the address of the recipient at the start of its transmission. Every system on the network receives each message but ignores those not addressed to it. While a system is transmitting, it also listens, and if it detects a simultaneous transmission, it stops, waits for a random time, and retries. The random time delay before retrying reduces the probability that they will collide again. This scheme is known as carrier sense multiple access with collision detection (CSMA/CD). It works very well until a network is moderately heavily loaded, and then it degrades as collisions become more frequent.

5. Wide area networks (WANs) connect computers and smaller networks to larger networks over greater geographic areas, including different continents. They may link the computers by means of cables, optical fibres, or satellites, but their users commonly access the networks via a modem (a device that allows computers to communicate over



Wide Area Network (WAN)

telephone lines). The largest WAN is the Internet, a collection of networks and gateways linking billions of computer users on every continent.

6. The Internet connects multiple WANs; as its name suggests, it is a network of networks. Its success stems from early support by the U.S. Department of Defense, which developed its precursor, ARPANET, to let researchers communicate readily and share computer resources. Its success is also due to its flexible communication technique. The emergence of the Internet in the 1990s as not only a communication medium but also one of the principal focuses of computer use may be the most significant development in computing in the past several decades.

(<https://www.britannica.com/technology/telecommunications-network> (abridged)

<https://www.britannica.com/technology/computer-network>

<http://computer-network-for-you.blogspot.com/2012/07/scope-of-networks.html>

II. Define the following statements as true (T) or false (F). Correct the false ones.

1. A LAN ensures communication over large geographical areas and makes it possible for users to share peripherals linked to it.

2. In a star network all computers are connected in a circular fashion.
3. Bridges are used to connect local area networks with identical architectures.
4. On the Ethernet the computer starts transmission only if it doesn't detect a carrier signal pointing to ongoing transmission.
5. Protocols define how data is transmitted between different computers within the same network.
6. The Internet is the successor of ARPANET developed by U.S. Department of Defense.

III. Complete the following sentences choosing the most suitable variant.

1. The most widely spread network configuration is _____.
 a) a star b) a ring c) a bus d) a hierarchy
2. To communicate two computers must observe a set of established rules known as _____.
 a) local standards b) network architecture c) telecom infrastructure d) protocols
3. For LANs with dissimilar architectures connection is provided by _____.
 a) gateways b) bridges c) routers d) switches
4. To gain an access to a WAN users should have to use _____.
 a) a hub b) a repeater c) a modem d) a fiber-optic cable
5. A technology used to connect wired local area networks, which is still popular at present, is _____.
 a) Internet b) Ethernet c) Intranet d) Extranet

IV. Read passage 2 and answer the following questions:

1. How are computers and peripherals linked in a LAN?
2. What components does a LAN comprise?
3. What does LAN operating system software permit users to do?

V. In passage 3 look for the information about the main local area networks configurations and explain what makes them different.

VI. Translate passage 4 into Russian.

VII. In passage 5 find what WANs are characterized by.

VIII. In passage 6 search for some facts about the history of the Internet and reasons for its success.

IX. Make an outline of the text.

X. Speak on:

1. Specific features of LANs and WANs.
2. LANs configurations and their characteristics.
3. The emergence of the Internet and its significance.

GRAMMAR FOCUS 2

2.6.2. Прилагательные и наречия, совпадающие по форме, а также наречия, имеющие две формы

<i>Прилагательное</i>	<i>Наречие</i>	<i>Наречие</i>
<i>free</i> – бесплатный	<i>free</i> – бесплатно	<i>freely</i> – охотно, свободно
<i>hard</i> – усердный, упорный	<i>hard</i> – усердно, упорно	<i>hardly</i> – едва ли, почти не
<i>high</i> – высокий	<i>high</i> – высоко	<i>highly</i> – очень, чрезвычайно
<i>last</i> – последний	<i>last</i> – после всех	<i>lastly</i> – наконец
<i>late</i> – поздний	<i>late</i> – поздно	<i>lately</i> – недавно
<i>loud</i> – громкий	<i>loud</i> – громко	<i>loudly</i> – громко
<i>near</i> – близкий	<i>near</i> – близко, около	<i>nearly</i> – почти, приблизительно

I. Compare the words in bold type by form and meaning, define their similarities and differences.

1. a) The fundamental discoveries in this new science were made **nearly** twenty years ago. b) In the **near** future major developments will take place in the field of information technologies.

2. a) This course of investigation will **hardly** suit our purpose. b) He tried **hard** to cope with his new job.

3. a) New types of calculations and **high** processing speeds can be achieved. b) A neural network is a group of **highly** interconnected simple processing elements, designed to mimic the brain.

4. a) These weakly-bound electrons can move about in the crystal lattice relatively **freely**. b) Invite companies to contact you for a **free** consultation.

5. a) Most supercomputers have a very large storage capacity, as well as a very **fast** input/output capability. b) CAD programs perform drawing functions very **fast**.

II. Give the Russian equivalents of the following word-combinations.

Radioelectronic devices; complex equipment; reliable security; optical connections; a remote site; a mobile system; a wireless channel; effective protection; a computational process; modern electronic products; advanced technological processes; new diagnostic equipment; programmable functional devices.

III. Give the Russian equivalents of the following sentences.

1. Modern IT environments store data on servers, endpoints and cloud systems. 2. Wireless networks can provide information at any appropriate location. 3. The means are mainly provided by cryptography. 4. Data encryption can prevent hackers from accessing sensitive information. 5. The optical receiver retrieves the original message from the cipher text. 6. Link encryption can be added to any network easily and is often useful. 7. There were no significant differences between the two groups in time taken or search terms used.

2.6.3. Степени сравнения прилагательных и наречий

Сравнительная степень

<i>Прилагательное</i>	<i>Наречие</i>
<p>1. <u>xer</u>¹ x</p> <p>↓</p> <p>более + прилагательное (какой?)</p> <p><i>faster access</i> – более быстрый доступ</p>	<p>1. <u>xer</u>¹</p> <p>↓</p> <p>более + наречие (как?)</p> <p>или</p> <p>наречие с суффиксом -e (-ее)</p> <p><i>faster</i> – более быстро, быстрее</p>
<p>2. <u>more x</u>² x</p> <p>↓</p> <p>более + прилагательное (какой?)</p> <p><i>more correct prediction</i> – более точный прогноз</p>	<p>2. <u>more xly</u>²</p> <p>↓</p> <p>более + наречие (как?)</p> <p>или</p> <p>наречие с суффиксом -e (-ее)</p> <p><i>more correctly</i> – более правильно, правильнее</p>

¹Односложные прилагательные/наречия; двусложные прилагательные, оканчивающиеся на *-er, -ly, -e, -w*/двусложное наречие *early*.

²Двусложные прилагательные (кроме тех, что указаны в сноске 1), многосложные прилагательные; двусложные наречия и наречия с суффиксом *-ly*.

Превосходная степень

<i>Прилагательное</i>	<i>Наречие</i>
<p>1. the <u>xest</u>¹ x</p> <p>↓</p> <p>самый (наиболее) + прилагательное (какой?)</p> <p>the <i>fastest access</i> – самый быстрый доступ</p>	<p>1. <u>xest</u>¹</p> <p>↓</p> <p>наречие с суффиксом -e (-ее) + всего (всех)</p> <p><i>fastest</i> – быстрее всего (всех)</p>
<p>2. the <u>most x</u>² x</p> <p>↓</p> <p>самый + прилагательное (какой?)</p> <p><i>the most correct prediction</i> – самый точный прогноз</p>	<p>2. <u>most xly</u>²</p> <p>↓</p> <p>наречие с суффиксом -e (-ее)</p> <p><i>most correctly</i> – правильнее всего (всех)</p>

¹Односложные прилагательные/наречия; двусложные прилагательные, оканчивающиеся на *-er, -ly, -e, -w*/двусложное наречие *early*.

²Двусложные прилагательные (кроме тех, что указаны в сноске 1), многосложные прилагательные; двусложные наречия и наречия с суффиксом *-ly*.

IV. Compare the words in bold type by form and meaning, define their similarities and differences.

1. a) One of **the latest** trends in telecommunications industry includes the usage of high-resolution content for driving improvement in the quality of information media. b) **The latter** procedure is much more complicated than the former one. c) In **the later** evolution of multichannel fiber transmission systems, two distinct methods of multiplexing data have been introduced. d) Wi-Fi's **latest** version is many times faster than DSL (Digital Subscriber Line) or cable connections.

2. a) **The most common** approach uses optics to create an effect called diffraction. b) Equipment that uses digital signals is **more common** and less expensive than comparable analogue one. c) Some of the methods used to spread a virus are through video files, images and **most commonly** through email attachments. d) **Less commonly**, the software running on one of the nodes that handles the packet makes a mistake.

3. a) One of **the most widely** used routing protocols in IP networks is the Routing Information Protocol (RIP). b) Google Search is by far **the most widely** used search engine on desktop and mobile devices. c) In order to make softphones **more widely** used, the technology should be accessible to more devices than just a PC or laptop. d) It is **widely** accepted that the risks associated with nanotechnology need to be analysed most carefully.

V. Give the Russian equivalents of the following sentences.

1. Cellular communication is the most popular way to connect people together for real-time communication and data transmission. 2. New networks must meet the growing demand for faster transmission speeds. 3. The independent system is the most widely spread type of a distributed system. 4. Advantages of optical fiber sensors include greater sensitivity, reduced size and weight, and immunity to electromagnetic interference. 5. In nearly every paragraph, there is one idea that is more important than all the others. 6. Information technology has made communication cheaper, quicker and more efficient. 7. Often the most difficult step in program development is the debugging stage.

2.6.4. Усиление степеней сравнения прилагательных

<p>1. <u>Even/much/far/still/a bit xer x</u></p> <p>↓</p> <p><i>еще/намного/гораздо/немного</i> + прилагательное (какой?)</p> <p><i>far better</i> results – <i>гораздо лучшие</i> результаты</p> <p><i>a bit faster</i> device – <i>немного более быстрое</i> устройство</p>
<p>2. <u>Even/much/far/still/a bit more x x</u></p> <p>↓</p> <p><i>еще/намного/гораздо/немного</i> + более + прилагательное (какой?)</p> <p><i>much more advanced</i> methods – <i>намного более передовые</i> методы</p>

3. by far/far/much xest x by far/far/much the most x x



Значительно/ *намного*/ *гораздо* + прилагательное с суффиксом -е (-ее)
(какой?)

by far the most demanding – *намного требовательнее (всех)*

VI. Give the Russian equivalents of the following sentences.

1. **Far easier** access to knowledge has been made by computerized indexes of scientific and technical journals. 2. Cable modems are **much more complex** than standard analog modems. 3. This might sound fantastic, but a scientist is looking for **by far the most innovative** solutions. 4. In this paper we focus on the main principles and approaches for **far more effective** web design. 5. The transistor replaced the **much bulkier** vacuum tube in radios, in computers, and in many scientific instruments. 6. The technology makes it possible to store vast amounts of data in **much smaller** devices than is currently possible.

VIDEO

«FIBER OPTICS AND HOW THEY WORK», 3:05

(https://www.youtube.com/watch?v=35JE3dIANNA&ab_channel=GalcoTV)

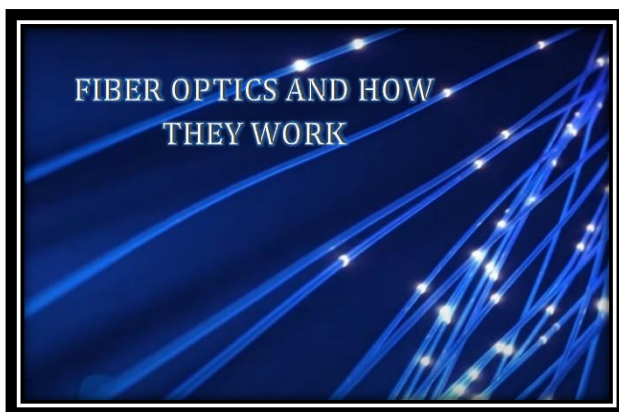

I. Before watching the video study the words which will help you understand the speaker.

an optical fiber	a very thin strand of plastic or glass that is used to transmit messages via light
a fiber optic cable	an assembly similar to an electrical cable, but containing one or more optical fibers that are used to carry light
a fiber optic bundle	a collection of optical fibers
bandwidth	the data transfer capacity of a computer network in bits per second
core	the central part of an optical fiber that carries light
cladding	one or more layers of materials of lower refractive index
refractive index	measures how much a material refracts light
refraction	the changing of light ray's direction (loosely called bending) when it passes through variations of matter
attenuation	reduction of signal strength or loss
bounce	move up and down repeatedly

II. Follow the link above, watch the video «Fiber Optics and How They Work» and define the statements as True (T) or False (F). Correct the false ones.

1. Fiber optic cables transmit data in the form of electrical signals.
2. Multi-mode fibers are used for transmitting signals over longer distances.
3. A fiber optic cable can be made of glass or plastic.
4. The basic components of a fiber optic cable are the core and cladding.
5. Fiber optic lines transfer analog information.

III. Watch the video again and name the phenomenon shown in this diagram. Explain the essence of it.

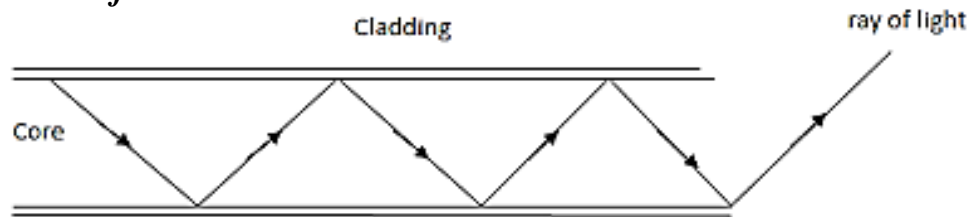

IV. Study the figure below and characterize these two types of an optical fiber. Say what makes them different and what they are used for.

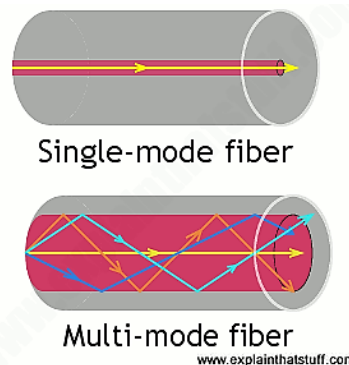

V. A. Compete the list of fiber optics applications.

- Computer networking
- Broadcasting
- ...

B. What other fields of application can you add to this list? Name advantages that fiber optics bring to these fields.

VI. Say if you use fiber optics at home and in what way.

VII. Do you think the speaker gave you a clear understanding of the key concepts related to fiber optics? What else would you like to know?

READING 3

I. Scan the text and define its main theme and problems.

INTRODUCTION TO PASSIVE OPTICAL NETWORK (PON)

1. It is universally known that fiber optics transmit data by light signals. As the data moves across a fiber, it needs separated ways to arrive at the targeted places.

Generally, there are two essential types to realize it: active optical networks (AON) and passive optical networks (PON). They are both able to provide ways to separate data and route it to the proper places. Nowadays, server providers invest billions of dollars in their access networks to meet the ever-increasing demand for high-bandwidth broadband. In addition to technology longevity, server providers also like to see technology evolution to ensure future consumer demands can be met. Consequently, the development of the PON type network is on the rise.

2. A passive optical network (PON) refers to a telecommunications technology that implements a point-to-multipoint (P2MP) architecture. In that case, unpowered fiber optical splitters can make a single optical fiber serve multiple end-points such as customers. Then there is no need to connect individual fibers between the hub and the customer. The system can be described as fiber-to-the-curb (FTTC), fiber-to-the-building (FTTB), or fiber-to-the-home (FTTH).

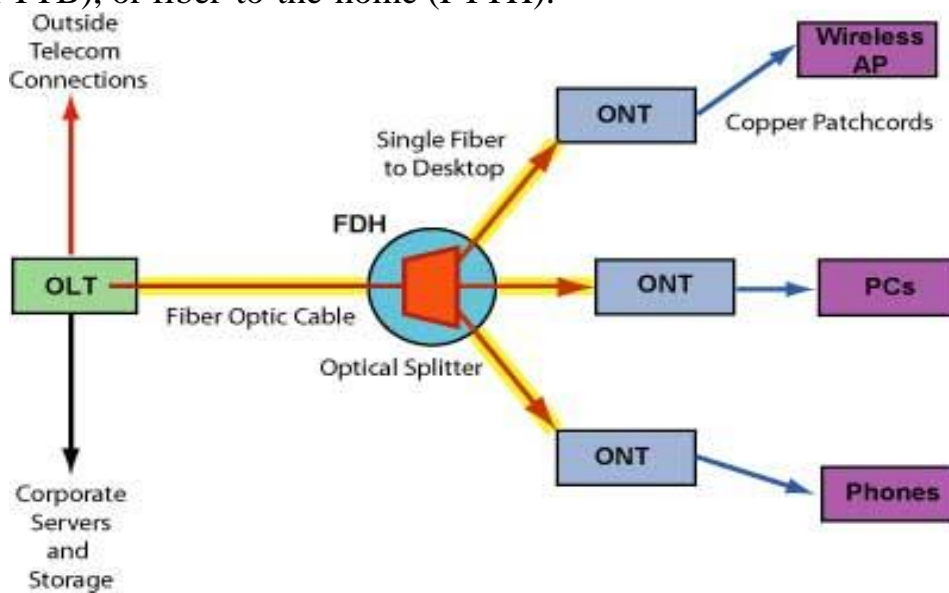

A PON consists of an optical line termination (OLT) and a number of optical network units (ONUs) or optical network terminals (ONTs). Normally, the OLT is placed at the server provider's central office and the ONUs/ONTs are put near end users. Up to 32 ONUs/ONTs can be connected to an OLT. The passive optical network simply describes the fact that optical transmission has no power requirements or active electronic parts when the signal is going through the network.

A PON system makes it possible to share expensive components for FTTH. A passive splitter that takes one input and splits it to broadcast to many users, which help cut the cost of the links substantially by sharing, for example, one expensive laser with up to 32 homes. PON splitters are bi-directional, that is signals can be sent downstream from the central office, broadcast to all users, and signals from the users can be sent upstream and combined into one fiber to communicate with the central office.

3. As early as the year 2009, the network PONs began appearing in corporate networks. Originally, they were designed to connect millions of homes for telephone, Internet and TV services. Afterward, users adopt these networks for their cheap price,

fast speed, low power consumption, easy management, etc. Here, the main benefits of a PON are listed below:

- Lower network operational costs.
- Elimination of network switches in the network.
- Lower installation (CapEx) costs for a new or upgraded network (min 200 users).
- Less network infrastructure.
- Large bundles of a copper cable are replaced with a small single-mode fiber optic cable.
- PON provides increased distance between the data center and desktop (>20 kilometers).
- Network maintenance is easier and less expensive.
- Fiber is more secure than copper. It is harder to tap. There is no available sniffer port on a passive optical splitter. Data is encrypted between the OLT and the ONU/ONT.

However, PONs also have some demerits. They have less range than an AON, which means subscribers must be geographically closer to the central source of the data. When failure occurs, it is rather difficult to isolate it in a PON. Moreover, because the bandwidth in a PON is not dedicated to individual subscribers, data transmission speed may slow down during peak usage times in an effect known as latency and it would quickly degrade services such as audio and video, which need a smooth rate to maintain quality.

4. From what we have discussed above, you may at least have a brief understanding of the passive optical network. In fact, a PON has been known for many years in the telecommunications field. Now a PON is finally making its way into the enterprise, providing opportunities for customers to deploy new infrastructures or new constructions. With the development of the technology, the network of a PON type mainly focuses on the commercial market. Especially, it performs well in healthcare, college campuses, hotels, and office buildings. The PON eliminates the need for switches and a wiring closet, which means a lower chance of failure.

(<http://www.fiber-optic-solutions.com/intro-optical-network-pon.html> (abridged))

II. Read the text again and define which of the following information is mentioned (T) or not mentioned (N) in the text.

1. A point-to-multipoint architecture of a passive optical network (PON) means that a single optical fiber is used to serve multiple user endpoints.

2. PON splitters can send signals in both ways: upstream and downstream.

3. Wave Division Multiplexing (WDM) is used to separate data streams in the PON operations.

4. The transmission distance of Active Optical Networks (AON) may reach up to 100 km.

5. A PON is called «passive» as it doesn't use electrically powered equipment in its path.

6. Optical Distribution Network (ODN) is a key component of the overall PON system.

III. Look through the text and find the definition and the main structural components of a PON. With the help of the schematic diagram given explain how it operates.

IV. Which passage contains the information about advantages and disadvantages of PONs? Name the most important of them. Say what makes PONs so attractive and popular among users. What drawbacks of PONs do you find most serious for consumers?

V. Scan the text again and name the main fields of PONs application.

VI. Give the main points of the text in 5-6 sentences.

VII. Telecommunications operators invest huge sums of money in the PON development. The world's first live 25G PON network has already been deployed which is a world record for broadband speed. It is said that we can expect the advent of 50G/ 100G PONs. Predict what benefits they can bring to users.

SUMMARY WRITING

I. Read the text and write a short summary of it.

WHAT IS A SUBMARINE CABLE? SUBSEA FIBER EXPLAINED

Our wireless world depends on a few hundred fiber cables laid on the ocean floor.

By Dan Swinhoe

Though we live in an increasingly wireless world, that connectivity depends on wires under the ocean.

Subsea or submarine cables are fiber optic cables that connect countries across the world via cables laid on the ocean floor. These cables – often thousands of miles in length – are able to transmit huge amounts of data rapidly from one point to another one.

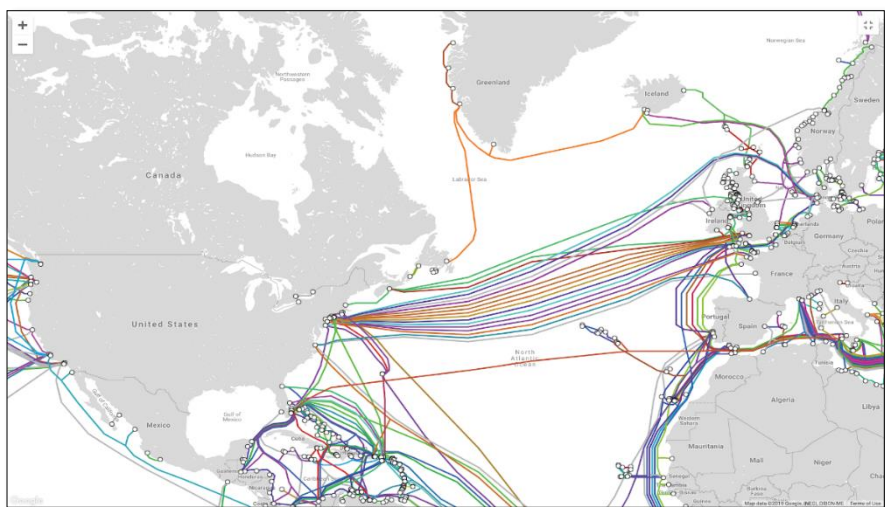

(<https://edition.cnn.com/2019/07/25/asia/internet-undersea-cables-intl-hnk/index.html>)

What is a submarine cable?

A submarine cable is a fiber optic cable laid in the ocean, connecting two or more landing points.

Today cables generally consist of the optical fibers that carry the information, which are then covered in silicon gel, then sheathed in varying layers of plastic, steel wiring, copper, and nylon in order to provide insulation to protect the signal and the cable from damage from wildlife, anchors and fishing, or weather and other natural events.

The cables are laid using ships that are modified specifically for this purpose, transporting and slowly laying the «wet plant» infrastructure on the seabed. These special ships can carry thousands of kilometers of optical cable out to sea. A special subsea plow is also used to trough and bury submarine cables along the seabed closer to shorelines where naval activities, such as anchoring and fishing, are most prevalent and could damage submarine cables.

«We've had submarine cables for over 150 years», explains Gil Santaliz, founder and CEO of New Jersey cable landing station NJFX, «and they've really been a way for communication between countries and continents».

Today there are more than 400 subsea cables in operation. Some connecting nearby islands can be shorter than 50 miles long. Others, traversing the Pacific, can reach more than 10,000 miles in length. Some connect single points across a body of water, others have multiple landing points connecting multiple countries.

Antarctica is the only continent not yet reached by a submarine telecommunications cable, though one is reportedly being considered to improve connectivity for researchers in the region.

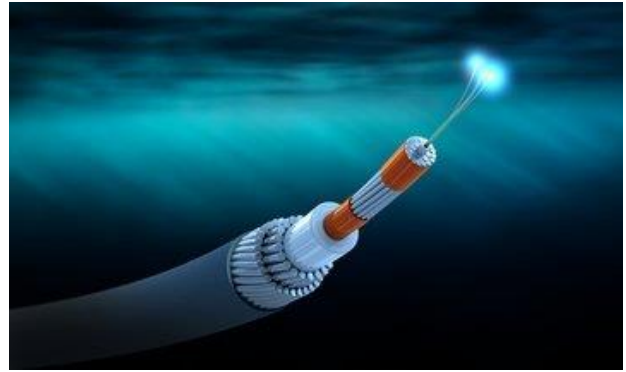

A submarine cable

Cable technology evolves quickly

Cables contain a number of repeaters, which boost the signal along the length of the cable roughly every 100km. At each end, the cables reach land within a cable landing station, from where the data is routed to its final location.

«Fiber optic cables leverage Dense Wavelength Division Multiplexing (DWDM), a technology whereby multiple wavelengths – each operating at rates of hundreds of gigabits per second – enable the information-carrying capacity of a submarine cable to be maximized», explains Brian Lavallée, senior director of solutions marketing at telecoms and networking firm Ciena.

Though capacity on existing cables is always increasing, Google's Virginia-to-France Dunant cable is currently the largest capacity cable, capable of 250 terabits per second.

Santaliz says that while satellite Internet capacity is rising while costs are dropping, terrestrial and subsea systems are exploding. «I would say in the next four years you'll see petabit systems going across the Atlantic Ocean», predicts Santaliz.

Following a trial earlier this year, the trans-Atlantic MAREA cable saw its potential capacity increase from 200Tbps to 224Tbps. The joint Microsoft-Facebook project was originally designed with a capacity of 160Tbps.

Japanese researchers recently achieved a new data transmission record, sending information at a rate of 319 terabits per second.

Cables were traditionally owned by consortium telecoms firms who would band together to spread the costs of manufacturing and deploying a cable in

exchange for being able to use some of the cable bandwidth. Today, cloud and hyperscale companies such as Facebook, Google, Microsoft, and Amazon are increasingly investing in subsea cables, both as part of traditional consortiums and as private projects.

(Data Centre Dynamics Ltd (DCD), 26 August 2021)

(<https://www.datacenterdynamics.com/en/analysis/what-is-a-submarine-cable-subsea-fiber-explained/abridged>)

FOLLOW UP

I. Study and role-play the following situation.

A passive optical network (PON) is often called the «last mile» between an Internet Service Provider (ISP) and the user. FTTH (Fiber-to-the-Home) is considered to be the main application of a PON. As an ISP you know that users want high speed Internet access, uploading and downloading files quickly, playing computer games online without latency and other things. You offer FTTH to users but they still call or e-mail a lot of questions. The most common are as follows:

1. How does FTTH work?
2. What equipment is necessary to have to install it?
3. Who will provide and maintain this equipment?
4. What services can FTTH provide to users?
5. Will Internet work in case of power cuts?
6. What problems might users have if it doesn't work? What solution can you offer?

II. In pairs or small groups discuss the above questions, give reasoned explanations and examples based on your own experience if any. Search the Internet for the necessary information. Prepare a post for your users to read on the ISP website.

III. Work in groups of three (Students A, B and C). Each student chooses the corresponding task to do.

Student A

Do you know when the first transatlantic undersea cable was laid? You may be surprised to learn that this happened a long time ago. Find out when this important historical event that began a global communication revolution took place. Search for some more facts on the Internet and share them with your groupmates.

The following links might be helpful to you:



<https://www.sciencemuseum.org.uk/objects-and-stories/how-perseverance-laid-first-transatlantic-telegraph-cable>



<https://www.wired.co.uk/article/transatlantic-cables>

Student B

Undersea cables have greater tolerance for failure than terrestrial ones but risks to be broken do exist. What might be the reasons for undersea cable failures? How are damaged undersea cables fixed? What happens to cables that are no longer used and need to be retired? Find out information on the Internet and present it to your groupmates.

Useful links:



<https://www.sciencemuseum.org.uk/objects-and-stories/how-perseverance-laid-first-transatlantic-telegraph-cable>



<https://www.wired.co.uk/article/transatlantic-cables>

Student C

Is it true that sharks can attack and destroy submarine cables? How can companies, for example, Google, protect their undersea fiber optic cables? Do research on the Internet and inform your groupmates.

Useful link:



<https://www.wired.com/2014/08/shark-cable/>

IV. Take turns to present the information you've found and be ready to answer the questions from other members of your group.

ADDITIONAL ACTIVITIES: PRACTICE TASK

I. Work in pairs or small groups.

Online gaming is very popular with young people as it provides an opportunity to play with friends and have real fun together. There are such famous games as Dota 2,

CS:GO, Fortnite and others. International online gaming tournaments are regularly held engaging millions of game players all over the world.

As online gaming has become massive, it is necessary to ensure gamers high-speed connection with minimal latency. To achieve this goal the company DATAIX, you are working for, has decided to lay a stand-alone optical submarine cable on the route **Stockholm** – (where there is a game server Dota 2 set up by Valve Co) – **Helsinki** – **Kotlin Island (Kronstadt)** – **St. Petersburg** (which is the only access point to this server in Russia).

To do this you have to perform the following tasks:

1. Study the typical scheme for a submarine cable system given below.

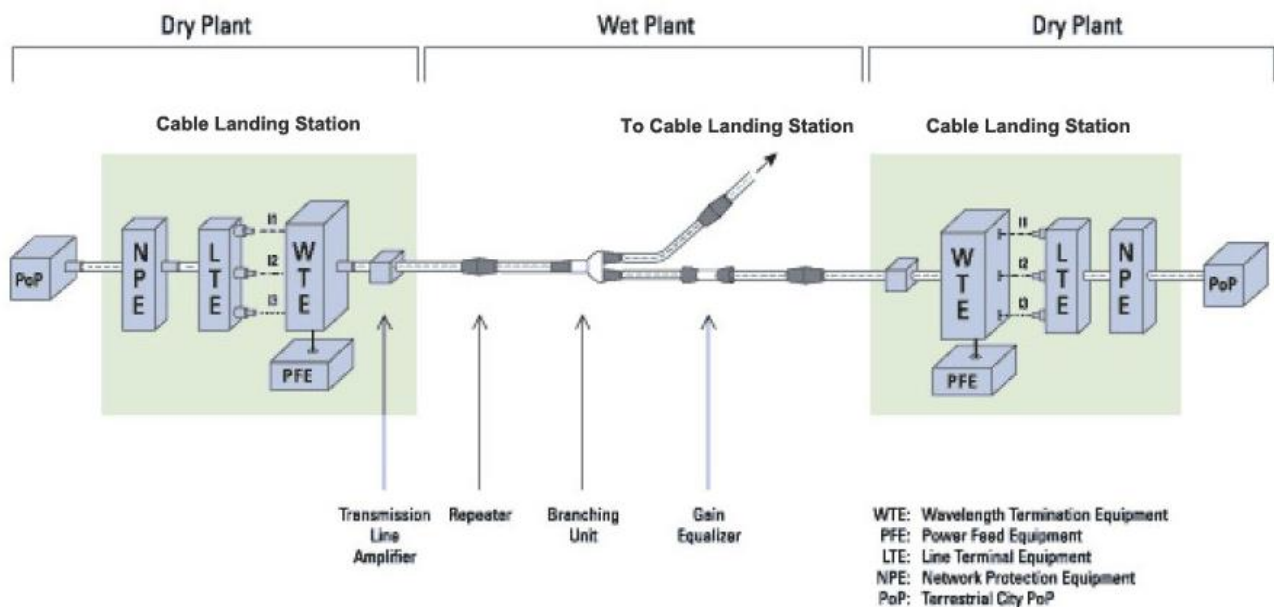

(<https://www.submarinenetworks.com/en/stations/page-71>)

2. Using Google Maps choose the route mentioned above for laying the optical submarine cable. Draw the route and measure the approximate cable length using the option «Measure the distance».

3. For the compensation of a signal loss on this long route, calculate the number of repeaters needed locating them at a distance of 100 km from each other. This will allow ensuring the data rate of up to 80 Tbits/sec.

4. Screenshot the route drawn and paste it in any graphic editor, for e.g. Paint Editor.

5. Mark the location of repeaters on the route with some conventional symbols.

6. Make a presentation of your results including the following slides:

- the typical scheme for a submarine cable system;
- the final drawing of the route from Paint Editor;
- photos of repeaters (search the Internet for some images or photos).

7. Be ready to comment on your presentation. Do you think this solution will help gamers to play online more efficiently?

PART II

WIRELESS COMMUNICATION

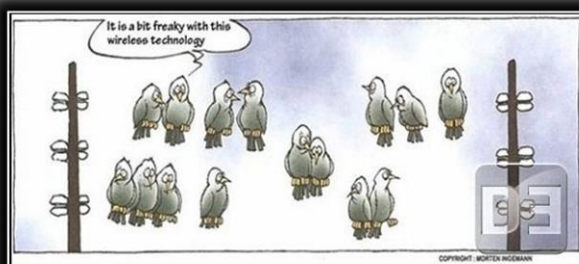

Wireless technology

Changes lives

«Wireless is freedom».

Martin Cooper

STARTING UP

I. In pairs, discuss the following questions.

1. What does the word «wireless» mean?
2. What do «Wi-Fi» and «GPS» stand for?
3. What is the origin of the term «Bluetooth»?
4. What wireless devices and technologies do you know?

II. Match the wireless device or technology to its description.

- | | |
|--|---|
| <ol style="list-style-type: none">1) wireless headphone2) satellite3) Qi4) GPS5) Wi-Fi6) Li-Fi7) Bluetooth | <ol style="list-style-type: none">a) This term is used to describe high speed wireless connection over short distances between mobile computing devices such as laptops and the Internet.b) It is great for exercising or listening to music.c) It is placed in orbit round the earth in order to collect information or for communication.d) It is a wireless optical networking technology that uses light-emitting diodes (LEDs) for data transmission.e) It is a space-based radio navigation system that allows the drivers to discover their location from anywhere on earth.f) It enables short-range wireless communication between electronic devices. It was named after a 10th-century Scandinavian king.g) It is a wireless charging standard, and the only one currently adopted by most major phone manufacturers. It is pronounced «chee». |
|--|---|

III. Make a list of achievements you consider most essential for wireless communication. Compare your ideas with those of your groupmates. Say if they are similar or different.

READING 1

I. Six headings have been removed from the text. Match the headings with the gaps at the start of the paragraph. There is one extra heading which you don't need to use.

A. Practical Use of Wireless Technology.

- B. Future Wireless Technology Trends.
- C. What is Wireless Communication?
- D. Birth of Wireless Technology.
- E. What is Wireless Technology?
- F. Dramatic Change in Wireless Technologies.
- G. Types of Wireless Communication.

II. Read the text and write out key words and phrases revealing its content.

III. In each part find the topical sentence.

1

Wireless technology allows the user to interact with two or more systems over a distance. It operates without the use of cables or wires of any type. It includes communications with the help of Infrared (IR) waves and radio frequency (RF). Wireless technology has always been ahead of technology and is generally more costly. It has provided an extra benefit of portability. It allows granting the user to send and receive information while traveling.



2

The origin of wireless technologies is attributed to the discovery of electromagnetic waves by Heinrich Hertz (1857–1894). The first commercial radio frequency communication device, the wireless telegraph, was invented by Guglielmo Marconi (1874–1937). It was made almost 50 years after the invention of commercial wired telegraph services by Samuel F. B. Morse in 1832. In 1896 Marconi went to England and took out a patent, the first ever granted for a practical system of wireless telegraphy. The next year Marconi’s Wireless Telegraph Company was founded to exploit wireless commercially. In 1901 Marconi achieved a dramatic success when he transmitted signals across the Atlantic Ocean by wireless. He was the first person who did anything of this sort.

3

The beginning of the 1990s brought a wireless revolution. It began with the emergence of the digital wireless network that leads to a social turn. There was a shift from wired to wireless technologies. It includes the spread of commercial wireless technologies like mobile phones, wireless computer networks, laptops, cellular networks, the Internet. The advancement in wireless technology is driven by microwave engineering and radio frequency. It allowed an increase in voice traffic along with the transmission of digital data which includes images, text messages, and streaming media.

4

Wireless communication is the most vital and growing technological area in the field of communication. It is a process of conveying information between two points wirelessly. In a wireless communication system, information is sent from the transmitter to the receiver which is also known as wireless transmission. Both are placed at a distance. A wireless communication system allows the transmitter and the receiver to be placed anywhere between a few meters to a few miles.

In this growing world, high speed wireless communication is an integral part of our lives. A few of the communication devices that operate wirelessly are GPS receivers, Bluetooth devices, mobile phones, Wi-Fi, remote controls, etc.

5

There are three kinds of wireless communication: Wireless Wide Area Network (WWAN), Wireless Local Area Network (WLAN), and Wireless Personal Area Network (WPAN).

- WWANs are designed using mobile phone signals. They are generally maintained and protected by cellular service providers. It allows you to stay in touch even when other forms of network access are not available.

- WLAN is a form of a wireless network that uses radio waves. The center network generally uses cables, with few access points that connect the wired users to the wired networks. Its range can be in any place from a single room to an entire building.

- WPAN is a network that uses Bluetooth technology and has a shorter range. They are used to connect well-matched devices near the main location. It has a range of about 30 feet.

6

The applications of wireless technology continue to grow and appear on the view. Wireless mouse and computer, wireless headphones and speakers, and wireless sensors are now conveniently available on the market.

Like broadcast radio and point-to-point microwave links, wireless devices and applications are getting increasingly common.

Wireless technology is also used to provide chances of communication in places where it is difficult to run cables, in addition to wired communication, for emergency employment and mobile communication.

Bluetooth is a new wireless technology that replaces the cable system. It allows the devices to be connected to any appliance or machine. For example, a camera to the computer, or an audio device to the Internet. A few of the examples of Bluetooth appliances include laptops, cordless telephones, and other devices.

Wireless technology can also be categorized based on data applications or voice or mobility – stationary, fixed, mobile, and portable. A few examples of voice applications employing wireless technology are cordless and cellular telephones.

The use of satellites for voice communication is another application of wireless technology.

It is also used in the field of medicine. One of the examples is Mobile Body Area Network (MBAN). It can measure heart rate, body temperature, oxygen level, and blood pressure. It operates by transmitting low powered wireless signals to receivers that feed into monitoring sites and nursing stations.

(<https://honestproscons.com/what-is-wireless-technology>)

IV. Read the statements below and decide which of them correspond to the content of the text. Find proofs in the text.

1. Wireless technology provides communication without a direct physical connection between the two parties.

2. Since the signals are transmitted in open space, it is possible that an intruder can intercept the signals and copy sensitive information.

3. The first wireless communication system came into use at the end of the 19th century.

4. Devices using wireless technology can be helpful in case of emergency.

5. Bluetooth tends to be simpler to use and needs less power than Wi-Fi.

6. Wireless gadgets are becoming more and more widespread.

7. A Mobile Body Area Network consists of small, intelligent devices attached on or implanted in the body.

V. In the text find the sentences containing the information about:

a) advantages of wireless technology over wired technology;

b) the discovery that made wireless technologies possible;

c) the changes caused by a wireless revolution;

d) types of wireless communication and their characteristic features;

e) application fields of wireless technology.

VI. Find the explanation of what wireless transmission is. Give examples of wireless communication devices.

VII. Sum up the text using key words, word combinations and topical sentences.

VIII. Express your attitude to the facts given in the text. Use the following phrases:

- I have found the text important/interesting/of great value because _____.

- I find the text worth reading because _____.

- It seems significant for me that _____.

- I've learnt a lot about _____.

IX. Say what new information you have learnt about wireless technology.

GRAMMAR FOCUS 1

2.7. Имя существительное как определение левое (именное словосочетание: N+N)

Существительных в роли определения к другому (главному) существительному может быть несколько. Если после артикля (или другого

определителя существительного) стоит ряд слов, чаще всего существительных в единственном числе и без предлога, то только *последнее* из них будет тем словом, к которому относится артикль и с которого надо начинать перевод этого словосочетания, мысленно ставя после него вопрос *какой?* Все остальные слова являются его определениями.

These error recovery *techniques* are well known. *Эти методы* исправления ошибок хорошо известны.

Словосочетание, состоящее из трех слов, среднее из которых может быть прилагательным, причастием (Participle I или Participle II) или герундием, следует также начинать переводить с *последнего* слова и продолжать в *строго обратном порядке*, причем при переводе должна быть соблюдена грамматическая форма среднего слова, например:

an oxygen <i>free</i> gas (free – adjective)	газ <i>свободный</i> от кислорода/ бескислородный газ
the double error- <i>detecting</i> code (detecting – Participle I)	код, <i>обнаруживающий</i> парные ошибки
computer- <i>simulated</i> drawings (simulated – Participle II)	чертежи, <i>моделируемые</i> с помощью компьютера
the CPU <i>cooling</i> system (cooling – Gerund)	система <i>охлаждения</i> ЦПУ

I. Give the Russian equivalents of the following noun phrases:

1) a fabrication process; an application area; the technology supplier; the telecommunication line; image transmission; signal processing; security support; a transmission channel; design activity; an information carrier; amplitude modulation; light signals; a frequency band;

2) a data system – a data exchange system; technology transfer – the technology transfer agreement; a telecommunication service – a telecommunication service request; computer systems – computer systems design; a protection system – a data protection system; access time – information access time;

3) a water-resistant watch; density dependent factors; frequency dependent selection; risk prone behavior; accident-prone equipment; an error free process; radiation-resistant materials; energy-efficient technologies;

4) operating devices; a radiating antenna; increasing productivity; the time-consuming method; a speed-limiting device; an information-bearing electromagnetic signal; echo-creating reflections; time-varying electric current; a light-carrying fibre; DNA-copying machinery;

5) a predefined process; the computerized analysis; increased pressure; computer-aided design tools; cloud-based technologies; a problem-oriented database; model-based expert systems; a diagnostic-related group; a speed-controlled motor; an Internet-enabled system; computer-supported work;

6) a coding system; a switching process; the modeling environment; the speed-enhancing algorithm; time-sharing systems; a problem-solving technique; modern distance learning courses; digital reading materials; video-sharing software; signal-processing techniques.

Признаки границ именованного словосочетания

Признаки <i>начала</i> именованного словосочетания	Признаки <i>конца</i> именованного словосочетания
Артикль, предлог: <i>a</i> basic fibre-optic system	Артикль, предлог: The mobile application <i>the</i> designer is to install ... The rapid current growth <i>during</i> this process is ...
Местоимение (притяжательное, указательное, отрицательное): <i>these</i> cellular radiophones	Личное местоимение (в общем падеже): The computer network <i>we</i> consider ...
Числительное: <i>three</i> common features	—
—	Глагол в личной форме: Computer models <i>are .../work ...</i>
Союз: We know <i>that</i> computer models are...	Союз: Computer-controlled machines <i>that</i> ...
Неличные формы глагола: <i>To define</i> information access time it is necessary ...	Неличные формы глагола: Personal computers <i>involving</i> ...

Примечание. Союзы *and* или *or* обычно не прерывают словосочетание: communications *and* data link – линия связи *и* передачи данных.

II. Define the boundaries of the noun phrases in the following sentences. Give their Russian equivalents.

1. An analog transmitter sends the electronic signals as modulated radio waves.
2. This information can be captured and interpreted by any intelligent wearable device.
3. Malware attacks are the most discussed area of the web application security.
4. The performance of the novel encryption algorithm is evaluated by conversion time and throughput.
5. The transceiver inside a cellular phone is a much more complex device than a conventional phone.
6. The most important fields of research in this area are information processing, pattern recognition, game-playing computers and applied fields such as medical diagnosis.

2.8. Неличные формы глагола как определение левое: причастие активное, причастие пассивное, герундий

2.8.1. Признаки распознавания причастия I (Participle I) и герундия (Gerund)

Причастие I	Герундий
<p>1. <u>ing</u> x¹</p> <p>↓</p> <p>перед существительным</p> <p>a processing device → устройство какое? → обрабатывающее (действие выполняется самим предметом: a device that is processing)</p>	<p>1. <u>ing</u> x¹</p> <p>↓</p> <p>без предлога, если стоит перед определяемым словом</p> <p>processing speed → скорость какая? обработки = скорость обработки (предназначение: speed for processing)</p>
<p>–</p>	<p>2. preposition <u>ing</u> x¹</p> <p>↓</p> <p>после предлогов of, about, for, in, at</p> <p>the process of providing technical support → процесс какой? = обеспечения технической поддержки</p>

¹Существительное может выполнять функцию субъекта (с), объекта (о), дополнения с предлогом (дп), определения родительного (ор).

III. Define the similarity and differences of the words in bold type, give the Russian equivalents of the word combinations below.

Working people – **working** principles; the **living** organism – **living** standards; a **writing** woman – a **writing** table; a **smoking** man – a **smoking** carriage; a **consulting** specialist – a **consulting** room; **boiling** water – a **boiling** point; a **reading** student – a **reading** hall.

IV. Define the features of Participle I and the Gerund in the function of an attribute.

1. The mobile industry is the fastest growing industry in the world. 2. There are two commonly used methods of modulating analog signals. 3. Various modulating and encoding schemes have been devised to provide protection against the errors caused by channel distortion and channel noise. 4. AI is considered as the growing ability of machines to learn and perform intelligently and smartly. 5. A satellite's thermal system maintains it in its optimum functioning temperature to ensure its continuous operation. 6. A directional transmitting antenna is used to focus the wave into a narrow beam.

V. Give the Russian equivalents of the following sentences.

1. In radio transmission a radiating antenna is used to convert a time-varying electric current into an electromagnetic wave or field. 2. Hikers can use the GPS tracking system to find their way. 3. The increasing use of smartphones and tablets as opposed to PCs is boosting overall time spent online. 4. FM radio systems have a special method of modulating the carrier. 5. Software engineering is a rapidly growing

industry in today's high-tech economy. 6. Cooling mechanisms of a satellite are activated when it gets too hot. 7. The analyst's job is to examine existing systems and identify opportunities for improvement.

2.8.2. Признаки распознавания Participle II (причастие пассивное) и Past Simple (прошедшее время)

Причастие пассивное	Прошедшее время
<p>1. <u>xed</u> x¹ ↓ перед существительным → причастие пассивное левое (ппл) → какой? = сделанный an <i>invented</i> device – <i>изобретенное</i> устройство</p> <p>2. x¹ <u>xed</u> ↓ после существительного → причастие пассивное правое (единичное) → какой? = сделанный The methods used helped² to decrypt the files. – <i>Использованные</i> методы <i>помогли</i> расшифровать файлы.</p>	<p>1. X <u>xed</u> ↓ после субъекта → сказуемое (СК) = кто делал, сделал? The scientist <i>invented</i> a device. – Ученый <i>изобрел</i> устройство.</p>

¹Существительное может выполнять функцию субъекта (с), объекта (о), дополнения с предлогом (дп), определения родительного (ор).

²Если в предложении стоят рядом две формы с окончанием *-ed*, то первая из них, как правило, причастие II (определение правое), а вторая – глагол в прошедшем времени (сказуемое).

Но:

Yesterday he demonstrated improved mechanisms. Вчера он *продемонстрировал* *улучшенный* механизм.

На русский язык причастие II (пассивное) единичное, стоящее справа от существительного, переводится *левым* определением.

VI. Compare the words in bold type by form and meaning, define their similarities and differences.

1. The technique **employed used** a single probe. 2. They **employed** a new type of robot. 3. The designers **used** different techniques to eliminate interception attacks. 4. The **encrypted** message contained sensitive information. 5. They **encrypted** the data to provide more security. 6. Moving across foreign domains resulted in **increased** risk to user information. 7. Computer viruses **increased** the vulnerability of an operating system. 8. The research **conducted contributed** to the solution of the problem **investigated**. 9. The scientists **conducted** a series of tests to prevent hackers' attacks.

VII. Find Participles II in the function of an attribute, name their features and give their Russian equivalents.

1. Each Web document contains coded information about what is on the page. 2. Wi-Fi 6 also promises reduced latency, greater reliability, and improved power efficiency. 3. The transmitted electromagnetic wave is picked up by a remote receiving antenna and reconverted to an electric current. 4. A user can rapidly receive updated traffic information for a requested area. 5. The solution of the problem required the concentrated efforts of many designers. 6. Encryption doesn't protect against users transferring restricted data to insecure media such as email, flash drives or mobiles.

VIII. Give the Russian equivalents of the following sentences.

1. The substance obtained contained some admixtures. 2. Then we discussed the quality of the machine tested. 3. The equipment produced is of high quality. 4. The device invented showed good performance. 5. The complexity of the technique involved increased considerably. 6. The results achieved confirmed the theoretical assumptions. 7. The investigation carried out provided both decryption keys and decryption applications. 8. Engineers should wait for the manager to officially accept proposed changes before implementing them.

WORD FORMATION

I. Explain the way of the word formation of the nouns below. Give their Russian equivalents:

- 1) footage, coverage, usage, package, breakage, carriage, advantage, message;
- 2) appliance, continuance, performance, maintenance, resistance, resemblance;
- 3) difference, emergence, dependence, consequence, evidence, existence, experience;
- 4) efficiency, emergency, latency, privacy, frequency, accuracy, secrecy;
- 5) attenuation, constellation, diffraction, distinction, implementation, reception;
- 6) ability, connectivity, humanity, mobility, possibility, reliability, safety, portability.

II. Compare the words by form and choose: a) nouns; b) verbs; c) adjectives.

Bandwidth; disadvantage; artificial; excitement; equipment; distribute; consumer; require; additional; ancillary; appear; receive; sophisticated; various; deliver; reporter; penetrative; precision; pressure; primary; provide; remain; assistant; broadcast; dearth; employ; convenient; advancement; customer; cordless; ensure; improve.

III. Choose an appropriate word and complete the sentences.

1. One _____ to receive live information over the air is by radio transmissions over frequencies that are close to the frequencies used by your car stereo.

- a) road b) path c) way d) manner

2. Computers, cellular phones, and other digital _____ are now inextricable parts of the structure of modern society.

- a) gadgets b) application c) appliance d) applicants

3. With at least four satellite signals, a GPS receiver can determine its _____ above the earth.

- a) quantity b) weight c) height d) depth

4. Several companies were in _____ to produce a breakthrough in miniaturized electronics.

- a) challenge b) rival c) competitors d) competition

5. The relative impact of these factors on _____ communication depends on the rate of information transmission.

- a) rely b) reliable c) reliability d) reliably

6. By understanding the risks, the researchers can now look to propose ways to minimize them and protect user _____.

- a) isolation b) separation c) loneliness d) privacy

7. This work demonstrates a _____ to this problem.

- a) answer b) decision c) determination d) solution

IV. Complete these sentences with the correct form of the words given in capitals at the end of the sentences.

1. Smaller sizes mean a significant increase in speed and more processing _____.

CAPABLE

2. The earliest examples of these standardized measures are _____, time, and weight.

LONG

3. Spyware is currently one of the major _____ threats to computers.

SECURE

4. Digital communications systems require each channel to operate at a specific _____.

FREQUENT

5. The first significant technological innovation was made by the American _____ Thomas Edison.

INVENT

WORD STUDY

I. Match the words in bold in the text of Reading 2 to the definitions 1–8.

1. _____, <i>noun</i>	delays in communication over a network.
2. _____, <i>noun</i>	a device for receiving a radio signal and automatically transmitting a different signal.
3. _____, <i>noun</i>	a group of associated or similar things.
4. _____, <i>noun</i>	the power that moves something, especially a vehicle, in a forward direction.
5. _____, <i>noun</i>	the height of an object or point in relation to sea level or ground level.

6. _____, <i>noun</i>	a rocket-powered vehicle used to send artificial satellites or spacecraft into space.
7. _____, <i>noun</i>	the making and sending out of television and radio programmes.
8. _____, <i>noun</i>	the return of a fraction of the output signal from an amplifier, microphone, or other device to the input of the same device.

II. Match the words to the ones with a similar meaning.

1) cellular	a) bring
2) sophisticated	b) continuous
3) artificial	c) supply
4) facilitate	d) request
5) deliver	e) stimulate
6) demand	f) improvement
7) provide	g) mobile
8) drive	h) man-made
9) seamless	i) make easy
10) advance	j) highly developed

III. Fill in the gaps with the words given in the box.

a) include	b) operate	c) avoid	d) complete
e) facilitate	f) transmit	g) ensure	h) cover

- Many GEO satellites _____ in the so-called C band.
- The 12 helical antennas _____ navigation pulses to users on the ground.
- 5G will operate on high-frequency bands but _____ shorter distances.
- Communication satellites _____ many everyday interactions that we take for granted.
- Take steps to _____ that your protection is up to date.
- Change the wireless channel on your router to communicate on a different frequency to _____ interference.
- Product manufacturers must _____ Wi-Fi interoperability certification testing.
- Some commercial GPS receivers _____ cellular or radio communications capability.

READING 2

I. Read the text and name the key points raised in it.

SATELLITE COMMUNICATION

1. Satellite communication, in telecommunications, is the use of artificial satellites to provide communication links between various points on Earth. Satellite communication has two main components: the ground segment, which consists of fixed or mobile transmission, reception, and ancillary equipment, and the space segment, which primarily is the satellite itself. A satellite is basically a self-contained

communications system with the ability to receive signals from Earth and to retransmit those signals back. The main components of a satellite consist of the communications system, which includes the antennas and **transponders** that receive and retransmit signals, the power system, which includes the solar panels that provide power, and the **propulsion** system, which includes the rockets that propel the satellite.

2. Satellites operate in three different orbits: low Earth orbit (LEO), medium Earth orbit (MEO), and geostationary or geosynchronous orbit (GEO). LEO satellites are positioned at an **altitude** between 160 km and 1,600 km above Earth. MEO satellites operate from 10,000 to 20,000 km from Earth. Satellites do not operate between LEO and MEO because of the inhospitable environment for electronic components in that area. GEO satellites are positioned 35,786 km above Earth, where they complete one orbit in 24 hours and thus remain fixed over one spot. It only takes three GEO satellites to provide global coverage, while it takes 20 or more satellites to cover the entire Earth from LEO and 10 or more in MEO. In addition, communicating with satellites in LEO and MEO requires tracking antennas on the ground to ensure seamless connection between satellites.



Aussat-1 Communications Satellite

3. A signal that is bounced off a GEO satellite takes approximately 0.22 second to travel at the speed of light from Earth to the satellite and back. This delay poses some problems for applications such as voice services and mobile telephony. Therefore, most mobile and voice services usually use LEO or MEO satellites to avoid the signal delays resulting from the inherent **latency** in GEO satellites. GEO satellites are usually used for **broadcasting** and data applications because of the larger area on the ground that they can cover.

4. Advances in satellite technology have given rise to a healthy satellite services sector that provides various services to broadcasters, Internet service providers (ISPs), governments, the military, and other sectors. There are three types of communication services that satellites provide: telecommunications, broadcasting, and data communications. Telecommunication services include telephone calls and services provided to telephone companies, as well as wireless, mobile, and cellular network providers. Broadcasting services include radio and television delivered directly to the consumer and mobile broadcasting services. Satellites also play an important role in delivering programming to cell phones and other mobile devices, such as personal digital assistants and laptops. Data communications involve the transfer of data from one point to another. Corporations and organizations that require financial and other information to be exchanged between their various locations use satellites to facilitate the transfer of data through the use of very small-aperture terminal

networks. With the growth of the Internet, a significant amount of Internet traffic goes through satellites, making ISPs one of the largest customers for satellite services.

5. One major technical disadvantage of satellites, particularly those in geostationary orbit, is an inherent delay in transmission. While there are ways to compensate for this delay, it makes some applications that require real-time transmission and **feedback**, such as voice communications, not ideal for satellites. Satellites face competition from other media such as fibre optics, cable, and other land-based delivery systems such as microwaves and even power lines. The main advantage of satellites is that they can distribute signals from one point to many locations. As such, satellite technology is ideal for «point-to-multipoint» communications such as broadcasting. Satellite communication does not require massive investments on the ground – making it ideal for underserved and isolated areas with dispersed populations.

6. In a relatively short span of time, satellite technology has developed from the experimental to the sophisticated and powerful. Mega-**constellations** of thousands of satellites designed to bring Internet access to anywhere on Earth are in development. Future communication satellites will have more onboard processing capabilities, more power, and larger-aperture antennas that will enable satellites to handle more bandwidth. In addition, other technical innovations such as low-cost reusable **launch vehicles** are in development. With increasing video, voice, and data traffic requiring larger amounts of bandwidth, there is no dearth of emerging applications that will drive demand for the satellite services in the years to come.

(<https://www.britannica.com/technology/satellite-communication>)

Note:

very-small aperture terminal (VSAT) – малый спутниковый терминал

II. Define the following statements as true (T) or false (F). Correct the false ones. Find proofs in the text.

1. MEO satellites orbit at a lower altitude than GEO.
2. Mobile and voice services are unsusceptible to the signal delays in GEO satellites.
3. Breakthroughs in the development of satellite technology have brought about successful satellite services.
4. Companies providing access to the Internet are considered to be one of the biggest users of satellite services.
5. Satellites are insignificant in transmitting programmes to mobile gadgets.
6. Satellite communication is a perfect solution for people living in remote regions far away from each other.

III. Complete the following sentences choosing the most suitable variant. There is one extra phrase which you don't need to use.

- | | |
|--|---|
| 1. Orbiting at around 35,000 km above the surface, GEO satellites take precisely 24 hours to _____ | a) suitable for broadcasting and data applications. |
|--|---|

- | | |
|--|--|
| <p>2. Only three GEO satellites are required for _____</p> <p>3. Its apparently fixed position above a point on the equator at an altitude of more than 36,000 km makes a GEO satellite _____</p> <p>4. Satellites are used by companies to _____</p> <p>5. Satellites compete with wired media and other systems located on the land such as _____</p> <p>6. Satellite communication is the best possible means for remote locations because there's no need to spend much money on _____</p> | <p>b) microwaves and cables carrying electrical power.</p> <p>c) perform a complete orbit of the Earth.</p> <p>d) larger amounts of bandwidth.</p> <p>e) the construction of the ground equipment.</p> <p>f) make the transfer of data easier.</p> <p>g) complete communications coverage.</p> |
|--|--|

IV. Read passage 1 and answer the following questions.

1. What does satellite communication imply?
2. What major parts does a satellite contain?
3. What is the main function of a communication satellite?

V. In passage 2 find the words or word combinations with a similar meaning to the following ones:

to function; middle; by reason of; to be placed; a harsh and difficult place to live in; to finish doing; above a particular place; to stay in one position; besides; a continuous link; to guarantee.

VI. Read passage 3 and name the cause of the signal delays in GEO satellites.

VII. Translate passage 4 into Russian.

VIII. In passage 5 find the most significant benefit and drawback of satellites.

IX. In passage 6 find the information about the work that is being done to make satellite technology more advanced.

X. Make an outline of the text.

XI. Speak on:

1. Main components of a satellite communication system and their functions.
2. Advantages and disadvantages of satellite communication.
3. Satellite applications.

2.8.3. Инфинитив в функции определения

1. X to x / to be xed



после определяемого существительного → инфинитив в действительном/чаще страдательном залоге (Infinitive Active/ Passive) → какой? = который нужно сделать/который будет делаться¹.

The problem **to consider** next is concerned with data transmission. а) Проблема, которую **нужно рассмотреть** далее, касается передачи данных.

б) Проблема, которая **будет рассматриваться** далее, касается передачи данных.

The terms **to be insisted** on are as follows. а) Условия, на которых **надо настаивать**, заключаются в следующем.

б) Условия, на которых **будут настаивать**, заключаются в следующем.

2. to x/ to be xed



после порядковых числительных (*the first, the second*) или прилагательного *the last* → инфинитив в действительном или страдательном залоге (Infinitive Active/ Passive) = заменяет придаточное определительное.

He is **the first to answer** questions. (He is the first who answers questions.) Он **первым отвечает** на вопросы.

His was **the last test to be checked**. (His was the last test which was checked.) Его тест **проверили последним**.

¹Инфинитив в функции определения включает в себя модальный оттенок долженствования, возможностей (иногда желания) (а) или передает будущее время в зависимости от ситуации и переводится на русский язык определительным придаточным предложением, с оттенком значения, указанным выше (б).

I. Define the similarity and differences of the word combinations below and give their Russian equivalents.

The books published – the books to be published; some figures referred to – some figures to be referred to; a signal detected – a signal to be detected; the programs verified – the programs to be verified; the problems solved – the problems to be solved; services offered – services to be offered; the factor considered – the factor to be considered; a circuit manufactured – a circuit to be manufactured.

II. Define the features of the Infinitive in the function of an attribute. Give the Russian equivalents of the following sentences.

1. The procedure to be followed depends upon the substance being tested. 2. We observed the evaporation of water, a phenomenon to be more fully described later. 3. The method to be followed is based upon some peculiar properties of these rays. 4. There are several precautions to be observed in making such experiments. 5. Alpha-radiation was the first radiation to be studied in detail. 6. The third item to be selected in image analysis is the shape of the picture. 7. There are some other properties of a metal to be considered at this point. 8. A large amount of information to be compressed on a small storage device is enabled by digital technology. 9. Telephone companies were the last to replace old copper wire systems with optical fiber lines.

2.9. Предлоги

2.9.1. Предлоги, указывающие на местоположение

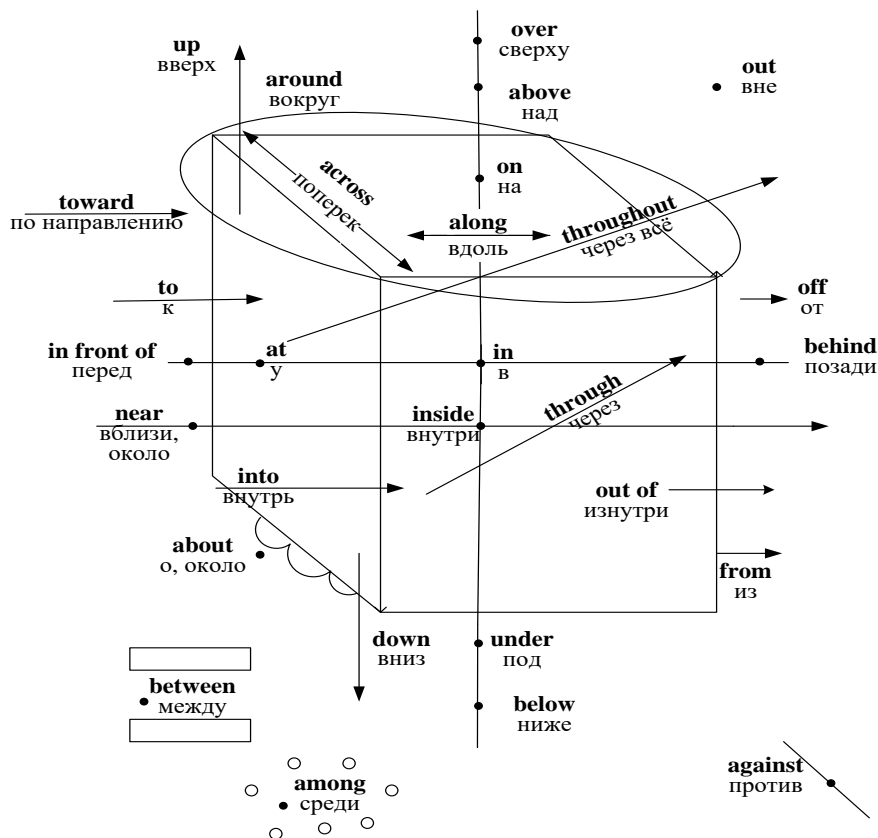

2.9.2. Предлоги, указывающие на время

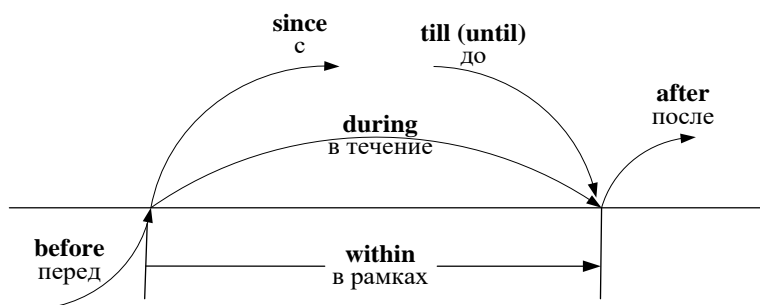

2.9.3. Составные предлоги

Запомните значение следующих предлогов.

FOR	ДЛЯ	WITHOUT	БЕЗ	OF	(ЧЕГО, КОГО)
BY	(ЧЕМ)	ON = UPON	НА	AS	КАК
		WITH	С		

according to	в соответствии с, согласно чему-либо
across from	напротив
ahead of	впереди, раньше
along with	наряду, вместе с, одновременно
apart from	помимо, кроме, не считая
as to/as for	что касается
as far as	до
as well	также, тоже
because of	из-за, благодаря, вследствие
but for	без, за исключением, кроме
by means of	посредством, при помощи
by way of	через
close to	рядом с
due to	благодаря, из-за, вследствие
except for	за исключением, кроме
in front of	перед
in spite of	несмотря на
instead of	вместо
on account of	из-за, вследствие
owing to	благодаря, из-за, вследствие
thanks to	благодаря, из-за
up to	до. Указывает: 1) на временной предел (вплоть): up to now – до сих пор; up to January – до января; 2) пространственный предел: up to page fifteen – до пятнадцатой страницы; 3) количественный предел: up to a hundred – до 100.

III. Choose the sentences in which the words in bold type are prepositions and give their Russian equivalents.

1. a) Infrared wireless communication is mainly used **for** short and medium-range communication. b) **For** wireless networks transmit signals by air, the problems of security are of special concern. c) Cellular providers typically meter their service, charging customers by the minute **for** voice and by the megabyte **for** data. d) The term «wireless» has been in use **for** more than a century. e) **For** Internet speed increases with broadband services, you can work from any part of the world in real time.

2. a) The slogan becomes functional **as** users are provided with options to try the service and download the free version. b) High-speed routers can serve **as** part of the Internet backbone. c) **As** the idea was false, it was rejected. d) In a digital signal, the information is encoded **as** a set of discrete values. e) Optical fiber is used **as** a medium

for telecommunication and computer networking. f) Such guidelines are extremely effective **as** they lead the visitors through the site content in a very simple and user-friendly way.

3. a) **Since** there are no cables and wires involved in wireless communication, there is no chance of communication failure due to damage of these cables. b) **Since** the real secrecy is in the key, its length is a major design issue. c) **Since** its introduction mobile telephony has undergone an enormous expansion. d) **Since** the invention of the transistor in 1947, metal wiring and other heavy hardware have been replaced by lightweight and compact microcircuitry.

IV. Give the Russian equivalents of the following sentences paying attention to the prepositions and prepositional phrases in bold type.

1. Modern telecommunication centres on the problems involved in transmitting large volumes of information over long distances without damaging loss **due to** noise and interference. 2. A worm sends copies of itself **by way of** a computer network which in turn harms the network. 3. Digital television is a telecommunication system for broadcasting and receiving moving pictures and sound **by means of** digital signals. 4. A master Bluetooth device can communicate with **up to** seven devices. 5. Computer programs operate **according to** set procedures, or logic steps, called algorithms. 6. Optical systems can transmit pulses of light **as far as** 135 kilometers without the need for amplification or regeneration. 7. In quantum computing the «qbit» **instead of** the traditional bit of information is used. 8. Information delivered over a channel should be authenticated **as to** origin, date of origin, data content, time sent, etc.

VIDEO

«**HOW DO CELLPHONES WORK?**», 1:34

(https://www.youtube.com/watch?v=-00Yf3VJpcA&ab_channel=NationalConsortiumforMissionCriticalOperations)

I. Before watching the video discuss the following questions.

1. Why is it significant to know how a cellphone works?
2. What devices does mobile communication technology include?
3. Where can a mobile communication device be helpful?
4. Is the use of cellular phones dangerous?
5. What is the difference between a cellphone and a walkie-talkie?

II. Watch the video and name the questions the answers to which are given in it.

III. Define the following statements as true (T) or false (F). Correct the false ones.

1. A cellphone uses radio waves to communicate.
2. A walkie-talkie is a two-way radio that works in full-duplex mode.

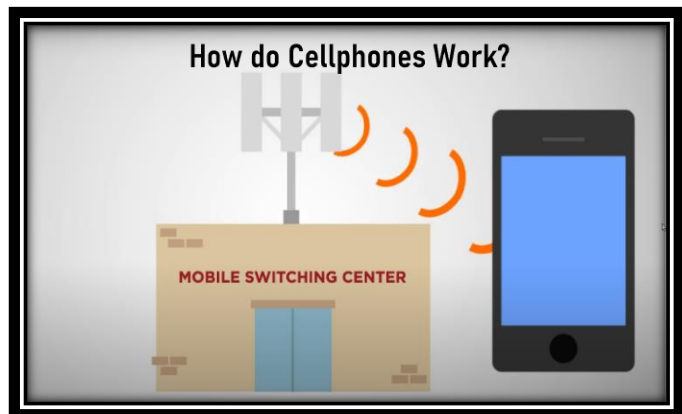

3. A cell phone offers full-duplex communication.
4. In case of half-duplex mode data can move in two directions at the same time.
5. A Mobile Switching Centre is a node system responsible for routing signals.

IV. Watch the video again and complete the sentences.

1. Cellphones interface with the network, in a _____ system, to transmit and receive radio signals.
2. The network is made up of _____ radio antennas and transmitters grouped in cells.
3. The basic geographic unit of a cellular system is a cell that is served by a particular _____.
4. All the cells are joined to a mobile _____.
5. It only takes a second to finish the entire _____ process.

V. Explain to your groupmates how a mobile communication system works.

READING 3

I. Scan the text and define its main problems.

ALL YOUR QUESTIONS ABOUT 5G – ANSWERED

1. Simply put, 5G is short for the fifth generation of wireless telecom technology, and it is expected to replace and augment the prevalent 4G LTE networks. The idea behind 5G networks is not only to provide faster connectivity speeds, but also to improve on reliability. In fact, a lot of 5G is expected to power and interconnect

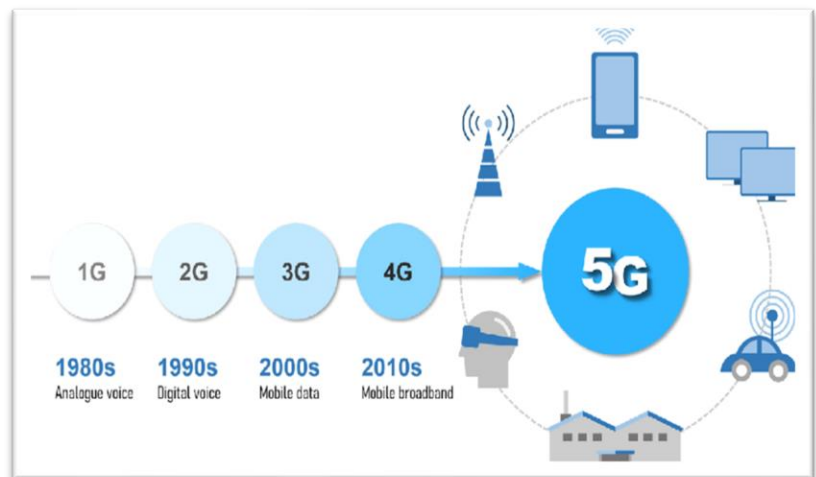

machines, devices and objects. It is slated to play a large role in the interconnectivity of the Internet of Things (IoT), deliver greater efficiency in terms of performance and drive new experiences.

2. The primary difference between 4G and 5G lies in the underlying technology. Unlike 4G, 5G networks will operate on three broad spectrum bands, namely – low, mid and high band spectrums. The low band spectrum provides great penetrative power, and speeds generally max out at 100 Mbps. The mid-band spectrum is known for lower latency and faster coverage, but has lower penetrative power; speeds top out at about 1 Gbps. The high band spectrum, also called the millimeter wave, is the cherry on top, with speeds going up to 10 Gbps and low latencies. The only drawback is the low coverage area that it can cater to.

3. The prevalent 4G technology ushered in a new era of mobile Internet. Developers, likewise, began to push more content via mobile and much of the

development is tailored to provide a superior mobile experience, be it for an application or a content streaming service. 5G, similarly, will bring about even more changes. It will not only improve on broadband services, but also serve as a platform for numerous devices and services. It will connect newer industries, from retail to education, transport to entertainment, and more.

4. A very obvious distinction lies in terms of the speeds offered by 5G connectivity. 5G is expected to be 10 times faster than 4G. While 4G connectivity has made 100 Mbps connections available to us, 5G will jump up a few notches to provide multi-Gbps rates. Estimated averages suggest that speeds are likely to reach 10 Gbps. For example, a full-length HD-quality film may take just a few seconds to download, and software updates will become much faster and easier. As such, high speeds will mean that 5G technology will carry larger amounts of data, giving way to a better connected world.

5. 5G does usher in a great sense of excitement amongst people. As mentioned earlier, a lot of it does resonate with higher speeds, but 5G will also have various other uses. The use of autonomous vehicles is expected to rise with the implementation of 5G technology. It will bring about a new era in terms of transportation. In fact, vehicles on the road are expected to communicate and learn from each other, thus enhancing safety.

6. Health care is another industry that will see great strides, and warrants a fair amount of excitement. The possibility of ultra-reliable low-latency communications can change health care. It is expected to bring changes in the fields of telemedicine, precision surgery, physical therapy with AR, and even remote surgery in the near future. Hospitals, on a similar note, can make use of a massive sensor network that can help monitor patient health and conditions.

7. As is evident with the implementation of new technologies from time to time, rumors have been circulating that 5G may cause health hazards. However, this is highly unlikely considering that much of the 5G spectrum consists of non-ionizing radiation. The frequency bands used in 5G are mostly low, and even the highest bands in usage do not reach ionizing wavelengths. Although 5G promises better security and privacy, that it is not necessarily guaranteed. The reason is, 5G inherits lots of security protocols and policies from its earlier generations. So, there will be security threats in 5G, unless they are resolved well in advance.

(<https://www.techopedia.com/all-your-questions-about-5g-answered/2/33732>)

II. Read the text again and define which of the following points are mentioned in it:

- a) the inventor of the Fifth Generation Network;
- b) if 5G technology will mean buying new equipment;
- c) what 5G technology is;
- d) if 5G will work in rural areas;
- e) a start date of 5G network deployment;
- f) reasons for people's worries about 5G.

III. Find the passages containing the information about the differences between 4G and 5G. Name and characterize them.

IV. Find the information about the possible impact of 5G technology on our lives? Tell your groupmates what amazing changes we can expect and in what spheres of life.

V. Which passage provides the information about the problems that might happen because of using 5G. Say if these risks are serious and explain the author's point of view.

VI. Give the main points of the text in 5-6 sentences.

VII. Express your opinion on 5G technology. Do you agree that 5G will fundamentally change our lives for the better?

SUMMARY WRITING

I. Read the article and write a short summary of it.

SPACEX PLANS TO PROVIDE STARLINK INTERNET ON MARS ONE DAY

By Evelyn Arevalo

SpaceX is deploying a megaconstellation of Internet-beaming Starlink satellites to provide Internet service to rural areas around Earth where service is unreliable and not available. The Starlink network could provide SpaceX with additional funding to develop a fleet of Starships to colonize Mars.

The company already launched approximately 888 Starlink satellites to low Earth orbit out of over 4,000 that will be part of the broadband network. Starlink customers will receive low-latency, high-speed broadband service from the satellites via a dish user terminal and Wi-Fi router device.

SpaceX President and Chief Operating Officer Gwynne Shotwell revealed that the company also plans to provide high-speed Internet on the Red Planet one day. In an interview with *Time Magazine*, she shared the reasons why SpaceX is creating the Starlink network. One of the reasons is to maintain communication with a future Mars colony. «Once we take people to Mars, they are going to need a capability to



communicate», she said. «In fact, I think it will be even more critical to have a constellation like Starlink around Mars. And then, of course, you need to connect the two planets as well», Shotwell told reporters.

The founder of SpaceX Elon Musk hopes to see a self-sustaining Mars settlement before the year 2050. His company runs around-the-clock operations to develop the spacecraft and technology that will enable humans to become a multiplanet species. During a recent *Mars Society Convention* teleconference, Musk said it is possible to set-up a variant of the Starlink network on Mars. – «...You just need a big laser coming from Earth», he said, «Probably want it to be in orbit so it

doesn't get atmospheric diffraction or attenuation. You want to go from a big laser from Earth orbit to Mars orbit and then you're going to need some relay stations for when Mars is on the other side of the Sun. So, you can't just shoot a laser through the sun», Musk explained. «[...] We want to be on track to become a multiplanet species and a spacefaring civilization in order to find out what the Universe is all about... And ensure the continuance of consciousness as we know it», he said. «As far as we know, we are the only life».

Shotwell shares a similar sentiment. «...Candidly, transporting people to other planets, I cannot imagine a goal worthier or more important», she told reporters. «...I also want to make sure you understand, we are not giving up on Earth, when we talk about building capability to move humanity to other planets... It's not giving up on Earth, it's actually just giving humanity another shot in case there would be some horrible event on Earth [...] a second planet to live», she added.

(*TESMANIAN, October 24, 2020*)

(<https://www.tesmanian.com/blogs/tesmanian-blog/starlink-on-mars>)

FOLLOW UP

I. Comment on the following quotations. Express your opinion on them.



«In my opinion, the future of mobile is the future of everything». *Matt Galligan*



«The wireless industry seems to have unlimited growth potential as the next generation of technology proliferates across the airwaves». *Tracy Lefteroff*



«New security loopholes are constantly popping up because of wireless networking. The cat-and-mouse game between hackers and system administrators is still in full swing». *Kevin Mitnick*

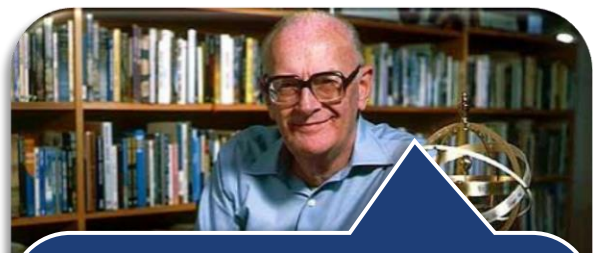

«A hundred years ago, the electric telegraph made possible – indeed, inevitable – the United States of America. The communications satellite will make equally inevitable a United Nations of Earth». *Arthur C. Clarke*

II. A. Work in groups. Fill in the missing information in the blocks of the diagram given below.

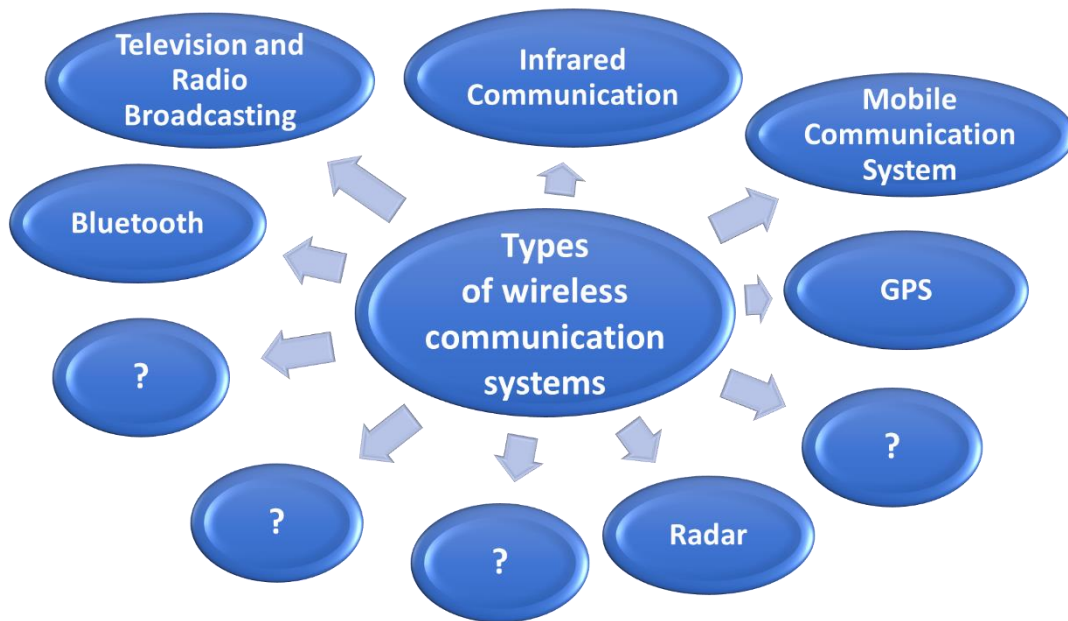

B. Using the diagram and the Internet resources discuss different types of wireless communication systems and their applications. Which of these applications do you find most promising? Explain your viewpoint.

III. Work in pairs or small groups. Wireless communication has a number of advantages and disadvantages over wired communication. Here you'll find mixed positive and negative characteristics. Rearrange them in the table below and be ready to discuss pros and cons of wireless communication.

Advantages	Disadvantages
Increased efficiency	Transmission speeds
Installation issues	Coverage
Cost savings	Flexibility
Security	New opportunities
Interference	Accessibility

IV. A. Role play. One of the main concerns of wireless communication is data security. Work in groups, A and B.

Group A

You are wireless network specialists planning to install a wireless network within the University campus. Discuss and list all possible risks to this network. Give arguments.

For details try the following links:



<https://us-cert.cisa.gov/ncas/tips/ST05-003>



<https://www.cisco.com/c/en/us/products/wireless/what-is-wi-fi-security.html>

Group B

You are network security specialists. Consider how the risks mentioned by group A can be minimized.

The links below might be helpful:



<https://us-cert.cisa.gov/ncas/tips/ST05-003>



<https://www.cisco.com/c/en/us/products/wireless/what-is-wi-fi-security.html>

B. Exchange your opinions giving arguments in favor or against. Work out recommendations how to secure data and inform your groupmates about them.

V. You will have to make a report at a video conference devoted to the latest developments in wireless communication. Search for the necessary information using the QR-codes or links below:



<https://www.cisco.com/c/en/us/solutions/technology-trends.html>



<https://scitechdaily.com/?s=wireless+communication>



<https://networkinterview.com/wireless-technology-trends>



<https://www.howtogeek.com/368332/wi-fi-6-what%E2%80%99s-different-and-why-it-matters>

Make a report with a presentation on the basis of the material you've found according to the plan given.

1. The definition of wireless communication and its types.
2. Technology involved.
3. Applications.
4. Possible future developments.

Be ready to comment on the slides of your presentation.

MODULE 3

INFORMATION TECHNOLOGIES

Grammar: THE COMPOUND AND COMPLEX SENTENCES

PART I

OPERATING SYSTEMS AND PROGRAMMING LANGUAGES



«Information is power, and modern information technology is spreading information more widely than ever before in history».

Joseph S. Nye Jr.

STARTING UP

I. Do you know what Information Technology is? Share your ideas with a partner. Which of the following is the appropriate definition of Information Technology?

1. Information Technology refers to the use of hardware and software for processing information.
2. Information Technology refers to the use of hardware and software for distribution of useful information.
3. Information Technology refers to the use of hardware and software for storage, retrieval, processing and distributing information of many kinds.
4. Information Technology refers to the use of principles of Physical sciences and Social sciences for information processing of many kinds.

II. Do the short quiz given below.

1. Interconnection of a computer is possible only with the help of _____.
A. secured messaging B. information technology C. tracking cookies D. processing
2. In information technology the processed form of data is called _____.
A. data processing B. system C. information D. instruction
3. _____ is known as the first computer programmer.
A. Charles Babbage B. Grace Hopper C. Alan Turing D. Ada Lovelace

Information technology (IT) is the use of computers to create, process, store, retrieve and exchange all kinds of electronic data and information.

III. Comment on the following statements. Express your viewpoint, agree or disagree with the opinions given.

1. Information technology (IT) benefits the business world and it allows organizations to work more efficiently and to maximize productivity and quality.

2. Information technologies have changed the way in which we communicate with each other, how we find information, work, conduct business and how we manage our social lives.

3. Information Technology is the main driver behind innovation, and without innovations, it would be difficult to survive.

READING 1

I. Read the title of the text. Make your predictions about its content.

INTRODUCTION TO INFORMATION TECHNOLOGY (IT) AND ITS EVOLUTION

The history that led to the development of IT as it's known today goes back millennia.

But the term **information technology** is a relatively recent development. Humanity has been manipulating, storing and communicating

information since the early Sumerians pioneered the written word in ancient Mesopotamia, about 3000 BC. The term IT did not appear until the mid-20th century, however, when an influx of early office technology appeared. The term was first published in the 1958 Harvard Business Review when authors Harold J. Leavitt and Thomas C. Whisler said «the new technology does not yet have a single established name. We shall call it «Information Technology»». Information technology has evolved and changed ever since.

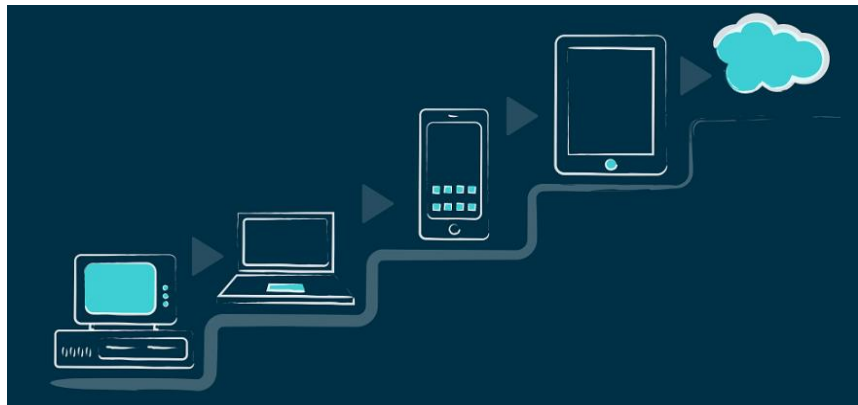

Abacus

Before the modern-day computer ever existed, there were precursors that helped people achieve complex tasks. The **abacus** is known as the earliest calculating tool. But it wasn't until the 1800s that the idea of programming devices really came along. At this time the Jacquard loom was developed, which used the system of punched cards, but electronic devices eventually replaced this method.

In the 1820s, English mechanical engineer Charles Babbage – known as the father of the computer – invented the *Difference Engine* to aid in navigational calculations. This was regarded as the first mechanical computer device.

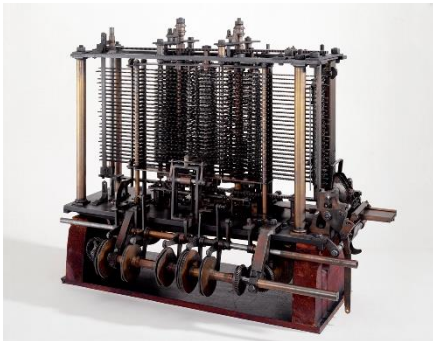

Analytical Engine

Then in the 1830s, he released plans for his *Analytical Engine*. The Analytical Engine would have operated on a punch card system. Babbage’s pupil, Ada Lovelace, expanded on these plans. She brought these plans beyond simple math calculations and designed a series of operational instructions for the machine – now known as a computer program. The Analytical Engine would have been the world’s first general-purpose computer. But it was never completed, and the instructions were never executed.

Many of the data processing and execution capabilities of modern IT, such as conditional branches (if statements) and loops, are derived from the early work of Jacquard, Babbage and Lovelace.

As computers evolved, so too did what eventually led to the field of IT. From the 1960s onward, the development of the following devices and tools set the stage for an IT revolution: screens, text editors, the mouse, hard drives, fiber optics, integrated circuits, programming languages such as FORTRAN and COBOL.

FORTRAN & COBOL

```
FORTRAN
X=SQRT ((A**2+Y)/(2.*B))

COBOL
SUBTRACT DEDUCTIONS FROM
GROSS-PAY GIVING NET-PAY.
```

In the 1940s, '50s and '60s, governments, defense establishments and universities dominated computing IT. However, it also spilled over into the corporate world with the development of office applications such as spreadsheets and word processing software. This created a need for specialists who could design, create, adapt and maintain the hardware and software required to support business processes.

Various computer languages were created and experts for those languages also appeared. Oracle and SAP programmers emerged to run databases, and C programmers to write and update networking software. These were in high demand – a trend that continues to this day, especially in areas of cybersecurity, AI and compliance.

Many information technologies owe their existence to the Internet and the World Wide Web. In the late '90s, the search engine giant Google was established. The turn of the century saw the development of WordPress, an open-source web content management system. This enabled humans to move from web consumers to active participants, posting their own content. Since the invention of the World Wide Web, the IT realm has quickly expanded. This includes developments in social media, internet of things, artificial intelligence, machine learning, big data, mobile computing and much more.

Information technology is no longer just about installing hardware or software, solving computer issues, or controlling who can access a particular system. In a modern context, the term «IT» is commonly used to describe computers and networks within a

business environment. It refers to their applications in generating, manipulating, storing, regaining, transmitting, handling, exchanging, studying and securing all data or information in an electronic format. In fact, today's modern hyper-connected data economy would collapse without information technology. We need information technology in today's world to establish faster communication, maintain electronic storage and provide protection to records. Technology offers various tools to boost development and to exchange information. Both these things are the objective of IT to make tasks easier and to solve many problems.

(<https://whatis.techtarget.com/feature/A-brief-history-of-the-evolution-and-growth-of-IT>
<https://www.complete-it.co.uk/the-history-of-information-technology>)

II. Scan the text and write out keywords and phrases revealing the content of the text.

III. Divide the text into logical parts. In each part find the topical sentence.

IV. Read the text again and decide which of these statements correspond to the content of the text.

1. The history of information technology, however, predates the invention of the modern digital computer by many centuries.

2. The basic concept of information technology can be traced to the World War II alliance of the military and industry in the development of electronics, computers, and information theory.

3. Abacus users calculate by moving a system of sliding beads arranged in columns on a rack.

4. Information technology could never have happened without the development of computers.

5. With the computer development, the concept of a compiler, or interpreter, became possible.

6. The advancement in computing contributed to IT revolution.

7. The growth of the Internet and the World Wide Web has made it appear that the world is witnessing the arrival of information technologies.

8. Since information technology is so widespread, the IT has found significant applications not only in business but in other areas of society.

V. In the text find the sentences containing the following information:

1) the origin of the term «information technology»;

2) early calculating machines;

3) IT revolution;

4) programming languages;

5) information technologies and the World Wide Web.

VI. Look through the text and find the facts which prove the significance of IT in the modern world.

VII. Sum up the text using the keywords, word combinations and topical sentences.

VIII. Express your attitude to the facts given in the text. Use the following phrases:

- It is full of interesting information _____.
- I find this text rather informative/cognitive because _____.
- I've learnt a lot about _____.
- I don't agree with _____ because _____.
- I share the author's view on _____.

IX. Say what new information you have learnt about IT and its evolution.

GRAMMAR FOCUS 1

**3.1. Сложносочиненное предложение
The Compound Sentence**

простое повествовательное предложение (С+СК)	сочинительный ¹ , союз	простое повествовательное предложение (С+СК)
--	-----------------------------------	--

¹ Иногда союз может отсутствовать. В таком случае между предложениями ставится точка с запятой.

The fastest desktop computers are called workstations, **and** they are used for scientific, engineering, or advanced business applications.

Millions of people are simultaneously using the Net; the most efficient route between a given source and destination can change from moment to moment.

Сочинительные союзы

простые	составные
and – и, а	as well as – так же как (и), а также
but – но, а, однако	not only ... but (also) – не только ..., но (также) и
or – или, иначе	both ... and – как ... так и; и ... и
so – поэтому, так что	either ... or – или ... или, либо ... либо
yet – однако, тем не менее	neither ... nor – ни ... ни

Для соединения независимых предложений могут употребляться некоторые **наречия**:

moreover – кроме того, более того	then – затем, тогда
nevertheless – тем не менее, однако	otherwise – иначе, в противном случае
still – тем не менее, все же, однако	(or) else – иначе, в противном случае
besides – кроме того	therefore – поэтому, следовательно
furthermore – кроме того, более того, к тому же	thus – таким образом, итак
however – однако, тем не менее	

I. Find the compound sentences. Give their Russian equivalents.

1. Facebook was not the first social networking website, but its introduction in 2004 was the most influential in the development of the medium. 2. Network interface cards can be built in or you can use plug-in adaptors. 3. Commercial users can

communicate over the Internet with the rest of the world and can do it very cheaply. 4. Fixed-base transceivers, such as those used at police stations, can fit on a desktop, and hand-held transceivers have shrunk in size as well. 5. Pure or basic research aims to clarify scientific principles without a specific end product in view; applied research uses the findings of pure research in order to achieve a particular commercial objective. 6. We have been using plastic packaging for many years; however, next year we are moving to more environmentally friendly materials. 7. Most television, radio, and voice communication, however, use the analog system and must be digitized.

II. Find the sentences with compound conjunctions. Give their Russian equivalents.

1. Telecommunications technologies include both wired and wireless services, among them the telegraph (now obsolete), telephone, radio, television, and the Internet. 2. These viruses replace either the programs that store information about the disk's content or the programs that start the computer. 3. Telenet and Tymnet were two packet networks, neither supported host-to-host communications. 4. In order for the concept to work, a new protocol had to be designed and developed; indeed, a system architecture was also required. 5. However, there are neither standards nor evaluation guidelines at present. 6. The manager not only objects to the terms of payment, but he also objects to the time of delivery. 7. Firewalls can also help combat the spread of computer viruses and other malware, or malicious software.

WORD FORMATION

I. Compare the words by form and choose: a) nouns; b) verbs; c) adjectives; d) adverbs.

Relatively; appear; mechanical; adapt; cybersecurity; operational; eventually; owe; existence; quickly; consumer; exchange; environment; solve; graphical; evolve; source; arrange; protection; dominant; spreadsheet; vulnerable; extension; prevalent; malware; occur; directly; embrace; capability; efficiently; functionality; gradual.

II. Explain the way of the word formation of the following words. Give their Russian equivalents.

Routinely; elimination; decode; physical; calculation; navigational; interact; instruction; conditional; especially; management; properly; enhancement; commonly; reestablish.

III. Choose an appropriate word and complete the sentences.

a) directly, directional, direction(s)

1. We can outline the promising _____ and tasks for further studies in computer programming.

2. Complexity is _____ linked to software reliability, so representing complexity is essential.

3. To pick a game move your _____ buttons to any of the symbols.

b) popular, popularly, popularity

1. Although this service is provided, it is not very _____ utilized.

2. As a general-purpose language C# is growing in _____ for developing web and desktop apps.

3. Apple's iOS is another mobile operating system used exclusively for iPhones, some of the most _____ mobile devices on the market.

c) functionality, functionally, functional

1. In computer science, _____ programming is a programming paradigm where programs are constructed by applying and composing functions.

2. _____ is the ability of a system to do the work for which it was intended.

3. Grouping of all _____ related elements is known as cohesion.

IV. Use the words given in capitals at the end of sentences and the suffixes below to make new words and fill in the gaps.

-ment	-tion	-ful	-able	-ness	-ity	-sion	-ety
-------	-------	------	-------	-------	------	-------	------

1. Developers work to create and refine a _____ application according to a planned roadmap.	SUIT
2. Linux is popular because of its ease of _____ and offers a _____ of options to those who understand how to use it.	CUSTOMIZE VARY
3. Evidence-based programming can enhance the _____ of the work.	EFFECTIVE
4. Experienced process engineers, design and software engineers as well as technicians are merging into a _____ project team.	POWER
5. iOS integrations have regular updates, new _____ to software, and continually are offering new features for users even if they have older devices.	EXPAND
6. In computer science, the computational _____ is the amount of resources required to run it.	COMPLEX
7. Tabulation of the voting data is stored in a _____ memory component and as a printed copy.	REMOVE
8. One technology that had made significant _____ in the area of accidental complexity was the _____ of high-level programming languages, such as Ada.	IMPROVE INVENT

WORD STUDY

I. Match the words to the ones with a similar meaning.

- | | |
|----------------|-------------------|
| 1) backbone | a) unsafe |
| 2) to overcome | b) to anticipate |
| 3) to explore | c) basis |
| 4) to mount | d) to investigate |
| 5) relatively | e) up-to-date |
| 6) malicious | f) to set up |
| 7) vulnerable | g) to get over |
| 8) techy | h) harmful |

- 9) advanced | i) computer expert
 10) to expect | j) comparatively

II. Match the words to their definitions.

- | | |
|-----------------------------|---|
| 1) malware, <i>noun</i> | a) to copy or move programs, information into computer's memory, especially from the Internet or a larger computer; |
| 2) techy, <i>noun</i> | b) to give attention, effort, etc. to one particular subject, situation or person rather than another; |
| 3) mediator, <i>noun</i> | c) a computer program that is used, for example, when doing financial or project planning; |
| 4) focus, <i>verb</i> | d) to come upon or meet with, especially unexpectedly; |
| 5) spreadsheet, <i>noun</i> | e) software that is specifically designed to disrupt, damage, or gain unauthorized access to a computer system; |
| 6) encounter, <i>verb</i> | f) a person who is expert in or enthusiastic about technology, especially computing; |
| 7) download, <i>verb</i> | g) a person or an organization that tries to get agreement between people or groups who disagree with each other. |

III. Replace the words in bold with the similar ones given in the box.

a) techies	b) vulnerable	c) encounter	d) spreadsheet	e) to mount
f) advances	g) backbone	h) malicious software		i) overcomes

- C is the most **unsafe** open-source language.
- Malware** is any program or file that is intentionally harmful to a computer, network or server.
- Our **computer experts** finally managed to clean up the file.
- The expansion of unmanned vehicles and platforms has been made possible by new materials, power sources and **developments** in computing.
- While the functional model retains the key features of the **program**, it also **gets over** its main limitations.
- Networks and communications are the **basis** on which the applications have been performing for quite some time.
- Such a program is costly and technically difficult **to set up**, and requires comprehensive planning, development and testing.
- If you **find** bugs during your install, please refer to the manual for further instructions.

IV. Fill in the gaps with the words given in the box.

a) complicated	b) mean	c) bugs	d) open source	e) algorithms
f) security	g) hackers	h) owns	i) determining	j) manufacture

The security of these operating systems is a crucial factor in **1.** ____ the dependability. Just keep in mind the security of these OSs does not depend on their **2.** _____. The element that Windows **3.** _____ a larger market share is also a factor. This makes Windows more attractive to **4.** _____. More users **5.** _____ more systems

and more databases to infiltrate. In software 6. _____, Linux wins the race. Linux is considered to be the securest of all the three. Why? The answer is not complicated at all. Linux is 7. _____, and that makes it open for review, looking for 8. _____ and elimination of backdoors. But Linux may be too 9. _____ for some users, and they may need to hire an IT professional with Linux administration certification. There was a time when Apple used to 10. _____ its chips, but now they all use the same chips from the same manufacturer. So, all of them have the same security level.

READING 2

I. Read the text and explain the term «an operating system».

LINUX VS MAC VS WINDOWS

1. An operating system is considered to be the backbone of any system. Without an operating system, the user and the system cannot interact. It acts as a mediator between both of these. We mainly have three kinds of operating systems, namely, Linux, MAC, and Windows. To begin with, MAC is an OS that focuses on the graphical user interface and was developed by Apple Inc. for their Macintosh systems. Microsoft developed the Windows operating system. It was developed so as to overcome the limitation of the MS-DOS operating system. Linux, created in the early 1990s by Finnish software engineer Linus Torvalds, is a Unix-like operating system that provides full memory protection and multi-tasking operations. It is open source.

2. A key difference among these three OSs is in how they store and arrange files.

FILE STRUCTURE

<p>Windows</p> <p>Windows follows a directory structure to store the different kinds of files of the user. It has logical drives and cabinet drawers. It has folders such as documents, pictures, music, videos and downloads. It also has files which can be a spreadsheet or any application program. It can have extensions as .txt, .jpg, etc. In addition to this Windows also provides a recycle bin where all deleted files can be stored.</p>	<p>MAC</p> <p>The file structure of MAC is commonly known as MAC OS X. It stores files within folders, also known as directories. The top, uppermost folder is known as the root directory. Folders located within (or beneath) the root directory are known as subfolders or subdirectories. You can explore the file system and directory structure by going to such directories as /Application, /Developer, /sbin, /tmp, etc.</p>	<p>Linux</p> <p>Linux has a completely different file structure from Windows and MAC. It was developed with a different code base. It stores data in the form of a tree. There is a single file tree and all your drives are mounted over this tree.</p>
--	--	---

3. Though all three OSs are widely used, there are significant differences between Linux vs MAC vs Windows. Windows is dominant over the other two as 88% of users prefer Windows. Linux is the least used operating system, with users accounting for 2%. MAC is popular and has an overall user base of 10% over the world. Desktops, laptops, smartphones, and other devices run on the Windows operating system. Computers, servers, and several embedded systems use Linux. MAC is primarily used on desktops and not recommended for servers due to its high cost.

4. **Security/Virus Proof:** When it comes to the risk of malware, MAC is less prone to security attacks due to its closed source software licensing. Due to its open-source licensing, Linux is more vulnerable than MAC, but it has less malware developed for it as it's less popular. However, being open source, Linux has a large community base to help anytime a security breach occurs. Of the three systems, Windows is the most prone to virus attacks due to its popularity among users. And as you'd expect, there are large numbers of malware developed for it. Notwithstanding, several free and paid anti-viruses offer security for Windows users.

5. **Cost/Price:** Windows is expensive, and the cost starts from \$100. Linux is free, and anyone can download and use it. MAC is costlier than Windows, and the user is forced to buy a MAC system built by Apple.

6. **Gaming:** There's a vast collection of games available for Windows, majorly due to its wide usage. If you're a gamer, that's good news. Windows-based PCs also benefit from a wide range of graphics cards and gaming hardware upgrades. There are games for MAC, but it doesn't compare to those of Windows. As for Linux, the available games are relatively few.

7. **User Target Group:** Windows is relatively cheaper than MAC, so it targets people of all ages, making it suitable for many homes and businesses. MAC is more prevalent among creatives – video editors, graphic designers, and animators. Linux generally finds popularity among techies – developers and programmers.

8. Overall, all these operating systems have their own pros and cons. It depends on the user and their choices and preferences of what they expect from the operating system. Windows can be used for playing games. Programmers can use Linux, and people who are interested in graphics can use MAC.

(<https://www.educba.com/linux-vs-mac-vs-windows>)

(<https://shiftweb.com/the-differences-between-mac-windows-and-linux>)

II. Define the following sentences as true (T) or false (F). Correct the false ones. Find proofs in the text.

1. An operating system provides an interface between a computer user and computer hardware.

2. MAC is an operating system created by Microsoft for their exclusive line-up.

3. Linux is a Unix-based open-source operating system capable of ensuring security and performing multiple tasks.

4. All these three operating systems are similar in the way they store files.

5. One of the biggest advantages of Windows over other operating systems is that it suffers from very few virus attacks.

6. There's no need to spend any money to obtain the license of Linux and download the high-quality software for it because it's free of cost.

7. MAC is beneficial for playing games in comparison with Windows and Linux.

8. Linux-based platforms are more suitable for advanced users engaged in creative activities.

III. Complete the following sentences choosing the most suitable variant.

1. There are three major types of operating systems: _____.

a) Windows, MAC, Solaris b) Linux, MAC, Ubuntu c) Windows, MAC, Linux

2. Windows file organization system works _____.

a) like a tree structure, following a hierarchical progression from the root

b) like a file cabinet structure, consisting of cabinet drawers that hold several files

c) if the topmost file folder is the root directory

3. _____ is leading over the other two operating systems within its users.

a) Windows b) Linux c) MAC

4. MAC OS X is less vulnerable to security attacks _____.

a) due to its open-source licensing

b) due to its popularity among users

c) due to its closed source software licensing

5. For people looking to spend more time on something classy and different, _____.

a) Linux is more prevalent b) MAC is a great option c) Windows is preferable

IV. Read passage 1 and answer the following questions:

1. What is the role of an operating system?

2. What are the main types of operating systems and their brief characteristics?

3. How were they created?

V. Read passage 2 and figure out the main differences in storing files by the following operating systems: MAC, Windows and Linux.

VI. In passage 3 find the information about the popularity of MAC, Windows and Linux. Name the devices that work on these three operating systems.

VII. Translate passages 4, 5 into Russian. Find the compound sentences and name their conjunctions.

VIII. Define the top benefits of these operating systems in gaming and target groups.

IX. Make an outline of the text.

X. Speak on:

1. Windows, MAC, Linux – pros and cons.

2. Your ideal operating system.

3. Operating systems of the future.

Complete the crossword using the clues given below.

CROSSWORD PUZZLE ON OPERATING SYSTEMS

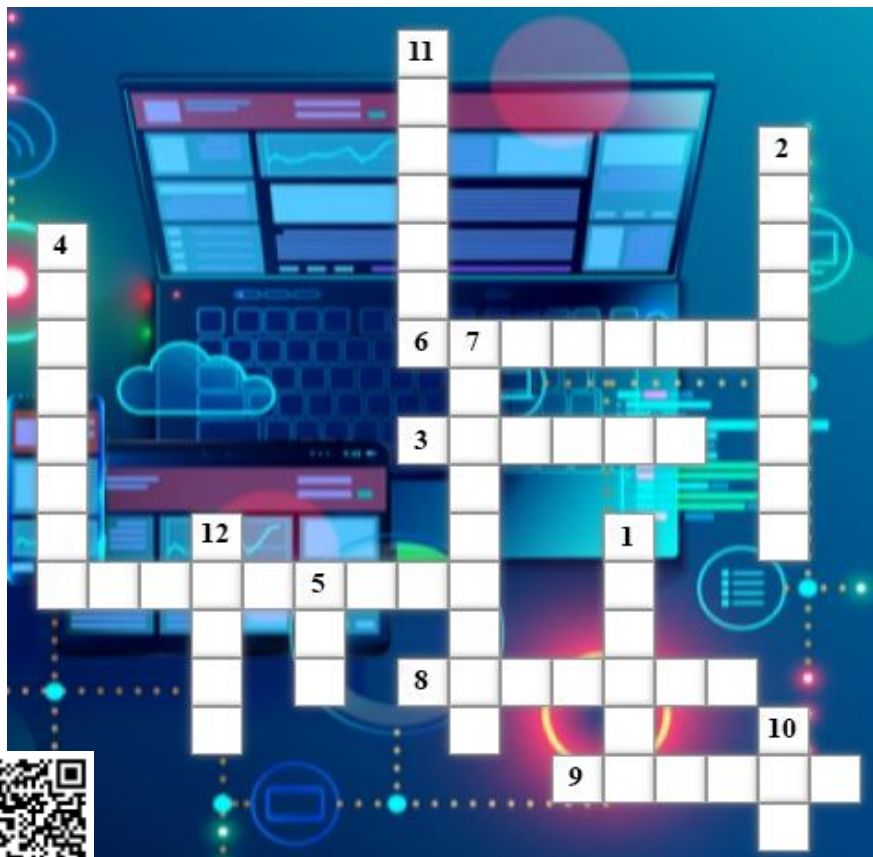

<https://learningapps.org/watch?v=pkd30mz8a22>

Across:

Down:

- 3. The part of a computer in which data or program instructions can be stored for retrieval.
- 6. Programs and other operating information used by a computer.
- 8. An open-source operating system used for smartphones and tablet computers.
- 9. A Unix-like computer operating system that is composed entirely of free software.
- 13. Achieving maximum productivity with minimum wasted effort of expense.

- 1. OS that serves as a platform for running web apps.
- 2. Another term for a central processing unit.
- 4. The machines, wiring, and other physical components of a computer or other electronic system.
- 5. An operating system used for mobile devices manufactured by Apple Inc.
- 7. What does the «O» stand for in OS?
- 10. Macintosh computer made by Apple.
- 11. Several graphical operating system families, all of which are developed, marketed, and sold by Microsoft.
- 12. An open-source operating system modelled on UNIX.

VIDEO

«TOP PROGRAMMING LANGUAGES TO LEARN TODAY», 4:10

(<https://www.youtube.com/watch?v=vSY0JocEA14>)



I. Before watching the video study the words which will help you to understand the speaker. Match the words to the definitions.

- | | |
|---------------------|---|
| 1) idiosyncrasy | a) suddenly start doing smth; |
| 2) to break into | b) the most difficult; |
| 3) concisely | c) a characteristic, habit or feature that smb. or smth. has; |
| 4) the toughest | d) fully, but in a few words; |
| 5) in demand | e) an advantage based on success in competition; |
| 6) competitive edge | f) needed or wanted by many people; |
| 7) distinct | g) to find out certain information or to decide; |
| 8) to determine | h) clearly separate and different. |

II. Discuss the following questions in pairs.

1. Why is it important to think what programming language to use?
2. How many languages should a programmer know? What is the best programming language for beginners to use? Why?
3. What are top programming languages today?

III. Watch the video and check if you were right.

IV. Watch the video again and define the following statements as true (T) or false (F). Correct the false ones.

1. The choice of a programming language is quite easy as the majority of languages have a lot of features in common.
2. Python is a good programming language to start a career with in the field of software development.
3. Java is most popularly used for Android application and operating systems development.
4. JavaScript and Java are very similar programming languages with the same usage.
5. JavaScript is a widely used programming language that allows making pages interactive.
6. C++ plays a notable part in the development of video games, robotic devices, web browsers, driverless vehicles, and much more.
7. Kotlin can be used for any kind of development, especially for iOS.
8. Kotlin is known for its brevity which can make a developer's work more productive.

V. Name the programming languages that are required today for Android application development.

VI. Say which programming languages a person should choose to become a system level programmer.

VII. Speak on the following issues, supporting your viewpoint:

1. Can you explain the difference between a front-end developer and a full stack developer? Which of them are in high demand today?

2. Which is the best programming language today? Which programming languages do you find important to learn?

3. Why do you think there's a lack of highly qualified developers on the job market today in spite of the fact that a lot of young people choose IT as a career?

4. What is the future of programming languages?

READING 3

I. Look at the title and predict the main issues raised in the text.

II. Read the introductory paragraph of the text and explain what makes Java one of the most widespread programming languages.

III. Read the rest of the text and put a heading in each gap. There is one extra heading that you don't need to use.

- A. Simplicity.
- B. Vast Developer Tools.
- C. Rich Set of Applications.
- D. Cross - Platform Compatibility.
- E. Language Diversity.
- F. Strong Community.

JAVA FOR WEB DEVELOPMENT: TOP BENEFITS OF THE PROGRAMMING LANGUAGE



One of the most popular programming languages for solving complex enterprise tasks is Java. This language has been a web developer's favorite for more than two decades now since its creation and launch in 1995 by Sun Microsystem. The language might be used in almost any domain, but is most suitable for enterprise solutions and for dealing with complex

issues, which usually occur in medical, pharmaceutical, finance, insurance fields. Companies like Google and Facebook have long embraced Java and selected it as a preferred choice in the enterprise space. Java is however not alone in the web programming world and developers have other options to choose from. There are

however some distinct advantages of Java that many developers have realized which we shall detail below:

1

Based on its popularity and use with many other sites, Java has a robust community supporting its use and ongoing development. This community works directly with Oracle to ensure that user requirements and enhancements get addressed in a timely and effective manner. In addition, the community also helps to solve security issues by sharing experience and providing answers to security-related questions.

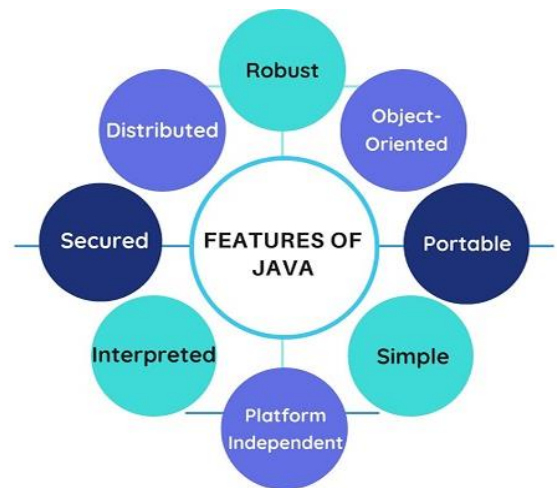

Diagram 1

2

Java offers advanced customization options through its development tools that can be utilized to increase the capability of applications. With Java, the scope of what the developer can achieve for your website is unlimited. Some of the most popular IDEs for Java app development are NetBeans and Eclipse. With these tools, the developer can create efficient applications that are highly productive and relevant to the digitized activities in today’s environment. Another plus is that the majority of the Java frameworks (such as Apache Struts, Dropwizard, Spark, etc.) are open source and can be used by any developer as out-of-the-box solutions.

3

Java is an easy-to-learn language, with English-like syntax and a limited number of characters. The operations using Java are efficient as it doesn’t take long to understand the codes and learn how things work on Java.

4

This is one of the main reasons for Java’s popularity. Unlike some other programming languages, Java is not dependent on one platform. Java applications can run on any operating system. The advantage with this is that a web developer can create a Java-based system on Windows, and use it in a UNIX operating system. Moreover, due to Java’s vast functionality, developers choose it as a language most suitable for tasks connected with the integration of one system into the other. This explains why Java is everywhere: smartphones, servers and ATMs. The list is almost endless. Estimates show that Java runs on more than 3 billion devices worldwide. No wonder Java is the most popular programming language in the world.

5

Most web-based applications are being built with Java as the main programming language. Some of the popular websites built using Java include eBay, Amazon, Facebook, and LinkedIn. These are successful online platforms that handle a lot of operations. The fact that they use Java is a reason enough to believe that it is the most

reliable programming language for web development. The world is being taken over by the Internet of Things (IoT), as the need for networked systems becomes ever more necessary.

Comparing the advantages and disadvantages of Java, the language also has its downside. One such drawback is the inability of Java to reveal information on lower-level hardware to developers. The major benefit of the Java programming language is the flexibility and adaptability it offers across a wide range of devices. Today, the software solutions offered by Java cut across all the major fields, and this trend is bound to continue with the gradual digitalization of the world. Moreover, Java is not only a programming language, but it is also a technology, an enterprise tool (J2EE), a mobile tool (J2ME), and it allows you to play mobile games, as well as online games. It is simple, free, has a rich API, portable, and distributed. It is also, secure, platform-independent, robust and has high performance. As such, it is reasonable to predict that the language will remain a leading programming language in the years to come.

(<https://nix-united.com/blog/java-for-web-development-top-benefits-of-the-programming-language>)



Diagram 2

IV. Define which of the following information is mentioned in the text.

1. Java is known as one of the most widely used programming languages.
2. Java specific methodology for distributed computing is called Remote Method Invocation (RMI).
3. Enterprise applications are one of Java's greatest assets.
4. Java is less complicated than C++; as a result, it uses automatic memory allocation and garbage collection.
5. Java has powerful development tools like Eclipse and NetBeans.
6. A developer can create a Java program on Windows and run the application on any other platform.
7. Java today is the foundation for most networked applications and is considered to be useful for web-based content, enterprise software, games, and mobile applications.
8. Java has an efficient memory allocation strategy as it divides the memory into two parts: Heap Area and Stack Area.

V. Look at diagram 1, name and describe briefly the main features of Java.

VI. Look at diagram 2 and comment on the Java development application areas.

VII. Which passage contains the information about the benefits and drawbacks of Java? Do you agree with the author? Express your idea, proving your point of view.

VIII. You are an experienced Java web developer. Convince your colleagues that Java is one of the leading programming languages today. Give the main points in 5-6 sentences.

SUMMARY WRITING

I. Read the article and write a short summary of it.

KOTLIN PROGRAMMING LANGUAGE: HOW GOOGLE IS USING IT TO SQUASH THE CODE BUGS THAT CAUSE MOST CRASHES

The Google Home app team explains why all Android developers should write their apps in Kotlin.

By Liam Tung

Google has detailed significant improvements that the Google Home team achieved just by rewriting the Google Home app in the modern programming language Kotlin.

Google is encouraging all Android developers to use Kotlin after its 2019 announcement that Android development will from here on be «Kotlin-first» as opposed to Java, which was historically the prioritized language for Android app development.

Announcing a new free beginner's Kotlin Android development course last week, Google claimed that 70% of the top 1,000 Android apps are written in Kotlin and one of them is from the team that develops the Google Home Android app.

The Google Home app isn't completely written in Kotlin yet, but as of June about 30% of the code base was rewritten in Kotlin from the legacy Java code. Kotlin is also being encouraged for all new features in the app.

The switch to Kotlin has had two major effects. First, it's reduced the number of NullPointerExceptions by 33% thanks to Kotlin's type system. This type of error is the largest cause of app crashes on Google Play, so reducing these can have a major impact on how users experience Android apps.

«Because Kotlin can make nullability a part of the language, tricky



situations can be avoided, like when inconsistent usage of nullability annotations in Java might lead to a missed bug», Google explains.

Kotlin has also helped Google's Home app developers become more productive as it requires much less code compared to the equivalent of existing Java code. Google points to the use of data classes and the Parcelize plugin as an example.

«A class which was 126 hand-written lines in Java can now be represented in just 23 lines in Kotlin – an 80% reduction», the company says.

The Google Home app has over one million lines of code, so to simplify development the team is taking advantage of Jetpack, a suite of libraries Google developed to improve app quality with less code.

The Google Home team has gradually added Jetpack libraries that replace custom solutions. Since these libraries help developers code in a less

verbose manner, it has helped make the code more readable for developers analyzing code previously written by other team members.

The promotion of Kotlin, which was created by Czech-based IDE maker JetBrains, is all part of Google's commitment to the language for Android app development.

Under Google's Kotlin-first policy, the company has committed to providing

better support to Kotlin. While the Android Studio IDE supports both Kotlin and Java, Jetpack libraries exclusively support Kotlin and new online-training material and samples, which are definitely available for Kotlin only may be available for Java. Google currently has 60 apps written in Kotlin, including Maps, Home, Play, Pay, and Drive.

(ZDNet, 20 July 2020)

(<https://www.zdnet.com/article/google-were-using-kotlin-programming-language-to-squash-the-bugs-that-cause-most-crashes>)

FOLLOW UP

I. Work in groups and discuss the following quotes.

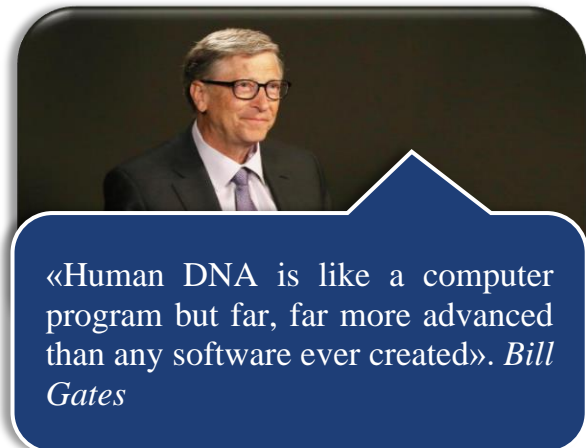
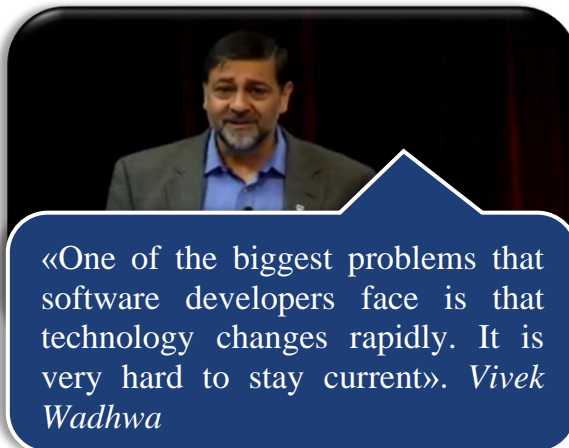
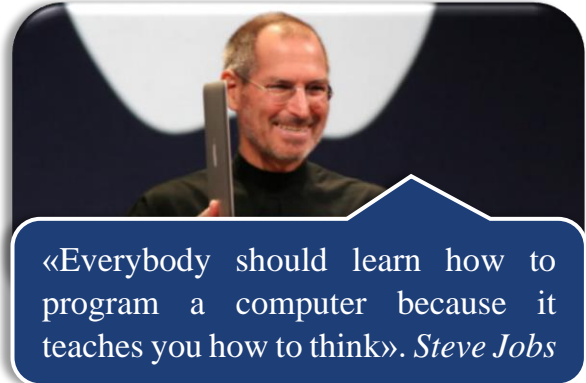
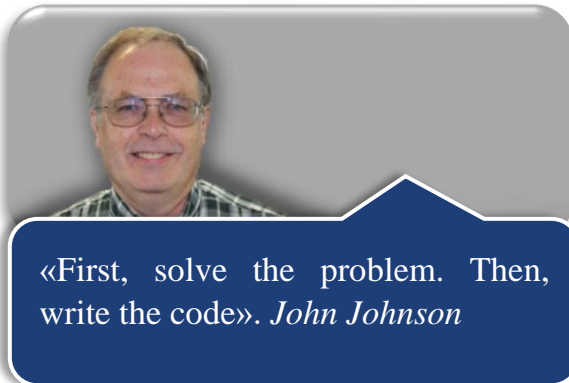

II. Discuss in pairs the positive and negative aspects of information technology, proving your idea. Is information technology making our life better or worse?

Here are some phrases you can use to talk fluently in this debate.

Good points	Bad points
It allows us to _____.	At the same time, there have also been

It means we have been able to _____.
It's enabled us to _____.

- side effects;
- unexpected outcomes;
- unwanted by-products;
- undesirable consequences.

Share your viewpoint with the rest of the group.

III. Role play the following situation in pairs.

Student A

You are a software developer, and your client wants to develop Android application for his company. Explain to him what tools (operating systems, programming languages, etc.) you are going to use and prove your choice.

Student B

You are a client, who needs Android application for your company. Ask questions about tools (operating systems, programming languages, etc.) which are necessary and effective for its development.

PART II

CUTTING EDGE TECHNOLOGIES AND CYBER SECURITY



«Technology is an enabler; you have to be at the cutting edge of technology – there is no choice».

Uday Kotak

STARTING UP

I. Do you know what Big Data Technology is? Share your ideas with a partner. Which of the following is the appropriate definition of Big Data technology?

1. Big Data is a virtual storage approach that allows users to use the Internet to store recorded data in a remote network.
2. Big Data refers to the process of applying computing power – the latest in machine learning and artificial intelligence – to seriously massive and often highly complex sets of information.
3. Big Data is essentially the recording of digital information in a storage medium, usually by electronic means.
4. Big Data refers to the collection and storage of data on hardware in a remote physical location.

that cannot be managed by common software tools. It requires certain technique integrated with the technologies which analyze the diverse, complex and massive amount of data.

Big Data Technology encompasses the solutions, systems, and tools used to manage and realize value from Big Data. This technology is defined by its ability to perform data management actions at very high scale: to transform, ingest, integrate, and prepare extremely large volumes of data so that it is available for use in analytics and in other enterprise systems.

Big Data Technology is characterized by at least one, but usually all, of the following characteristics: massive volume, high velocity (rate of change) and a widely varied type, and unpredictable veracity. Together, these are known as the Four Vs of Big Data:

Volume: As the name implies, Big Data is of such massive amounts – terabytes, petabytes, or even zettabytes – and is growing at such a rate that calculating its precise size is impossible.

Velocity: The vast majority of modern data changes constantly, and the rise of streaming data from the Internet of Things and other sources is only increasing the rate of change and growth.

Variety: Big Data encompasses any and all types of data, regardless of how or where it was created. This includes structured data, such as credit card transactions, as well as unstructured data, such as email, video, audio, images, social media, and so on.

Veracity: Big Data Technology addresses the need to verify the quality and reliability of enormous amounts of data streaming into systems at high speed from multiple sources, in multiple formats.

Big Data Technology is broadly classified into two categories:

1. Operational Big Data Technologies

Operational Big Data Technologies indicate the volume of data generated every day, such as online transactions, social media or any information from a particular company used for analysis by software based on Big Data Technology. It acts as raw data to supply Big Data analytics technology. Few cases of Operational Big Data Technologies include information on online ticket bookings, online shopping which is your Amazon, Flipkart, Walmart, Snap deal, data from social media sites like Facebook/Meta, Instagram, WhatsApp and etc.

2. Analytical Big Data Technologies

Analytical Big Data Technologies concern the advanced adjustment of Big Data Technologies, which is rather complicated than Operational Big Data. This category includes the real analysis of Big Data, which is essential to business decisions. Some

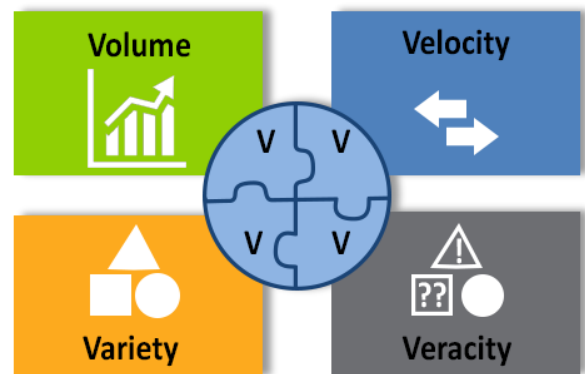

examples in this area are stock marketing, weather forecasting, time series and medical records analysis.

The Big Data environment is continually evolving. The amount of data is only going to increase, and analytics technology will become more advanced. Surely, Big Data is one of the technologies that is going to shape the future of humanity.

(<https://www.informatica.com/nz/resources/articles/what-is-big-data.html>
<https://www.jigsawacademy.com/big-data-5-new-technologies-emerge-2017>)

IV. Read the text and decide which of these statements correspond to the content of the text. Give proofs.

1. Big Data comprises the huge volume of data that is impossible to process using traditional software.

2. The development of open-source frameworks, such as Hadoop and Spark, was essential for the growth of Big Data because they make Big Data easier to work with and to store.

3. Big Data is commonly described by four main features.

4. Big Data is variable as it includes multiple data types from different sources.

5. The phenomenon of Big Data is closely tied to the emergence of data science, a discipline that combines math, programming and scientific intuition.

6. Security is a big concern for organizations with Big Data stores as such stores can be attractive targets for hackers or advanced threats.

V. Look through the text and find the definition of Big Data Technology.

VI. In the text search for the information that describes:

- a) the origin of the term «Big Data»;
- b) essential qualities of Big Data Technology;
- c) its two main types and their distinctive features;
- d) the application of Big Data analytics technology.

VII. In the text find the facts which prove the significance of Big Data Technology.

VIII. Sum up the text using key words, word combinations and topical sentences.

IX. Express your attitude to the facts given in the text. Use the following phrases:

- It is full of interesting information _____.
- I find this text rather informative/cognitive because _____.
- The information given in the text is of great value because _____.
- I've learnt a lot about _____.

X. Say what new information you have learnt about Big Data Technology and its future prospects. Do you think it will be useful in your future professional activities?

3.2. Сложноподчиненное предложение
The Complex Sentence

3.2.1. Структура сложноподчиненного предложения

1.	главное предложение (С+СК)	(,)	подчинительный союз ¹	придаточное предложение (С+СК)	.	
ARPANET was the basis on <i>which</i> the Internet was developed.						
2.	подчинительный союз	придаточное предложение (С+СК)	(,)	главное предложение (С+СК)	.	
<i>When</i> a program is running, it is in the process of instructing the computer.						
3.	субъект главного предложения (С)	(,)	подчинительный союз ¹	придаточное предложение (С+СК)	(,)	продолжение главного предложения (СК)
A bus <i>to which</i> nodes are connected in a branching structure is the most common arrangement.						

Подчинительные союзы²

as long as as soon as because if until (till) while whether which provided/providing (that) unless in order that so that	пока; до тех пор, пока как только потому что, так как если, ли до тех пор, пока (не) в то время как; пока ли который; что при условии, что; если если ... не (для того) чтобы (для того) чтобы; так что
---	--

¹Подчинительный союз может выполнять функцию субъекта придаточного предложения:
Organisations *that* have large amounts of printed information are working to transfer their information into databases.

²Придаточные предложения могут начинаться вопросительными словами *who, whose, what, which, how* и т. д., которые выполняют роль подчинительного союза.

lest	чтобы не
though/although	хотя
in spite of the fact that	несмотря на то, что
whereas	тогда как; несмотря на то, что
than	чем, нежели
as if/as though	как если бы
(not) so ... as	(не) так (такой) ... как
as ... as	так же (такой же), ... как (и)
such ... that	такой ... что
so ... that	так (такой) ... что

I. Compare the subordinating conjunctions by their form and meaning, define their similarities and differences. Give the Russian equivalents of the sentences.

1. Users can share data, files, or applications on the network as if these resources resided on their respective computers. 2. If the software fails its alpha or beta tests, the programmers will have to go back to an earlier step. 3. The arithmetic/logic unit performs arithmetic operations, such as addition and subtraction, and logic operations, such as testing a value, to see if it is true or false. 4. A firewall also logs information about network traffic, which can help an administrator understand and prevent attacks. 5. As a computer processes data and instructions, it temporarily stores information in main memory, which consists of random-access memory (RAM). 6. Although there may be thousands or millions of virtual connections across the public network, the switches in the public network behave as if there is only one connection. 7. We will proceed as though each link is implemented by a single cable/fiber. 8. People with digital cameras can record events, send the images to a Web server, and allow people anywhere in the world to view the images almost as soon as they are recorded.

3.2.2. Усилительная конструкция

It is (was, will be) ... ***that*** (who, which, when) = ***именно, только, как раз***

It was Popov ***who*** invented radio.

Именно Попов изобрел радио.

It was not until 1995 ***that*** he published his book.

И ***только*** в 1995 году он опубликовал свою книгу.

II. Find the sentences with the Emphatic Construction. Give their Russian equivalents.

1. It was with the miniaturization of integrated semiconductor circuits, however, that the modern microprocessor became possible. 2. It was not until the early 1990s that the Internet became accessible to the general public. 3. It was a highly structured language that supported good programming techniques. 4. The existence of one of the earliest electronic digital computers was kept so secret that it was not revealed until decades after it was built. 5. The techniques that direct the precise motions of a tool can also be used to direct the motions of a robotic device, and it is in this application that the microprocessor excels. 6. It is widely believed that human intelligence has three principal components: consciousness, the ability to classify knowledge and retain it, and the ability to make

choices. 7. It is the semiconductor fabrication technology which now offers the opportunity of producing vacuum tubes as small as transistors.

WORD FORMATION

I. Compare the words by form and choose: a) nouns; b) verbs; c) adjectives; d) adverbs.

Responsible; connection; manage; application; security; reliability; urgently; deliver; digital; network; convert; storage; continually; allow; accessible; flexible; store; transfer; communicate; technical; virtual; maintain; handle; competent; subscription; capacity; rapidly; share; performance; support; management; extremely; encompass.

II. Explain the way of the word formation of the following words.

Recover; significantly; usage; respectively; completely; combination; storage; invisible; disconnect; establishment; implementation; scalability; maintenance; inclusion.

III. Choose an appropriate word and complete the sentences.

a) access, accessible, accessibility

1. Ultimately, it's advantageous to invest in projects that make technology more _____ so that as many people as possible can participate fully in an increasingly online world.

2. Most security experts agree that it is not the location of data that matters, but the means of _____.

3. As the cloud grows and more competition is injected into the market, _____ becomes a major issue to ensure both a level-playing field and proper coverage of the market.

b) reliable, reliably, reliability

1. Without putting measures in place to optimize costs, cloud computing is unlikely to be _____ cost-effective.

2. The evidence suggests that weak links in the _____ of security in cloud computing occur at the user level.

3. Other than periodic component failures and cloud service downtimes, the performance of cloud computing as delivered by cloud service providers is generally very _____.

c) changeable, changeability, change(s)

1. The advent of Big Data technology has brought visible _____ in the process of doing business.

2. As businesses operate in a highly _____ environment, they need to respond to transformation in a positive fashion.

3. This is the result of the _____ of demand and the variability of the offer.

IV. Complete this text with the correct form of the words given in capitals at the end of the sentences.

Big Data refers to large **1. _____** of data that are so complex and expansive that they cannot be interpreted by humans or by **2. _____** data management systems. When properly analyzed using modern tools, these huge volumes of data give businesses the **3. _____** they need to make informed decisions. New software **4. _____** have recently made it possible to use and track Big Data sets. Much of this user information would seem **5. _____** and unconnected to the human eye. However, Big Data analytic tools can track the relationships between hundreds of types and sources of data to produce **6. _____** business intelligence.

COLLECT

TRADITION

INFORM

DEVELOP

MEANING

USE

WORD STUDY

I. Match the words to the ones with a similar meaning.

- | | |
|----------------------------------|------------------|
| 1) store, <i>verb</i> | a) to handle |
| 2) recovery, <i>noun</i> | b) available |
| 3) link, <i>verb</i> | c) to keep |
| 4) usage, <i>noun</i> | d) to connect |
| 5) refer, <i>verb</i> | e) equipment |
| 6) deliver, <i>verb</i> | f) application |
| 7) manage, <i>verb</i> | g) restoring |
| 8) efficiency, <i>noun</i> | h) to provide |
| 9) hardware, <i>noun</i> | i) effectiveness |
| 10) accessible, <i>adjective</i> | j) to relate |

II. Match the words to the definitions.

- | | |
|-----------------|--|
| 1) to eliminate | a) the process of keeping something in a particular place until it is needed; the space where things can be kept; |
| 2) network | b) to make something continue at the same level, standard, etc.; |
| 3) scalability | c) the use of something in an effective way; |
| 4) to maintain | d) to remove or get rid of something; |
| 5) storage | e) the size or power of a piece of equipment; |
| 6) deployment | f) a large system consisting of many similar parts that are connected together to allow movement or communication between or along the parts, or between the parts and a control centre; |
| 7) capacity | g) the ability of something, especially a computer system, to adapt to increased demands. |

III. Choose the correct word to complete these sentences.

1. Cloud computing is the on-demand availability of a computer system _____, especially data storage and computing power.

- a) ability b) resources c) performance d) programs

2. Computer capacity _____ the amount of server and storage resources that are available to the databases in an instance.

- a) defines b) meets c) follows d) links

3. IBM Cloud offers the most open and _____ public cloud platform for business.

- a) wide b) possible c) secure d) important

4. The main purpose of cloud computing is to let users benefit from the _____ technologies even without having any deep knowledge about them.

- a) enormous b) various c) casual d) clean

5. Also cloud technology _____ the necessity to forecast future capacity needs.

- a) stores b) copes c) protects d) eliminates

6. Cloud computing allows you to _____ your service quickly in fewer clicks.

- a) deploy b) take c) include d) become

7. Private cloud resources are not as cost effective as public clouds but they _____ more efficiency than public cloud.

- a) increase b) convert c) offer d) connect

8. Cloud scalability refers to the _____ to add or remove IT resources in response to a changing demand.

- a) command b) quality c) shape d) ability

IV. Fill in the gaps with the words given in the box.

- | | | | | |
|--------------|-----------|---------------------|-------------------|--------------|
| a) expensive | b) traced | c) cloud services | d) infrastructure | e) resources |
| f) features | g) access | h) computation time | i) optimize | j) term |

Many aspects of cloud computing can be **1.** _____ as far back as the 1950s, when universities and companies rented out **2.** _____ on mainframe computers. At the time, renting was one of the only ways to **3.** _____ computing resources as computing technology was too large and **4.** _____ to be owned or managed by individuals. By the 1960s, some computer scientists began proposing ideas that anticipated some of the major **5.** _____ of cloud computing today. Cloud computing, however, didn't become a mainstream reality and a popular **6.** _____ until the first decade of the 21st century. This decade saw the launch of **7.** _____ like Amazon's Elastic Compute in 2006, Google Cloud Platform in 2008, Windows Azure (now Microsoft Azure) in 2010, IBM's Smart Cloud in 2011, and Digital Ocean in 2011. These services allowed existing businesses to **8.** _____ costs by migrating their in-house IT **9.** _____ to cloud-based resources and provided independent developers and small developer teams **10.** _____ for creating and deploying apps.

READING 2

I. Read the text and name the key points raised in it.

MAIN CHARACTERISTICS OF CLOUD TECHNOLOGY

Cloud computing is one of the leading technologies in modern world. Cloud computing refers to any kind of hosted service delivered over the Internet. These

services often include servers, databases, software, networks, analytics and other computing functions that can be operated through the cloud. Files and programs stored in the cloud can be accessed anywhere by users of the service, eliminating the need to always be near physical hardware. The cloud is basically a decentralized place to share information through satellite networks. Every cloud application has a host, and the hosting company is responsible for maintaining the massive data centers that provide the security, storage capacity and computing power needed to maintain all of the information users send to the cloud. The most prominent companies hosting the cloud are major players like Amazon (Amazon Web Services), Microsoft (Azure), Apple (iCloud) and Google (Google Drive), but there's also some other players, large and small. These hosting companies can sell the rights to use their clouds and store data on their networks, while also offering the end user an ecosystem that can communicate between devices and programs.

2. Generally, cloud computing follows three delivery models:

Public. This is the most common type and all of the players mentioned above (Amazon, Microsoft, Apple and Google) run public clouds accessible anywhere with login credentials and the right web app.

Private. This model offers the same kind of flexibility as the public cloud, but with the infrastructure needs (hosting, data storage, IT staff, etc.) provided by the companies or users of the service.

Hybrid. Hybrid cloud computing is a combination of the public and private models. The two cloud types are linked over the Internet and can share resources when needed (e.g. if the private cloud reaches storage capacity or becomes corrupted, the public cloud can step in and save the day).

3. Most cloud computing services fall into three major categories:

Infrastructure as a Service (IaaS). This is the most common service model of cloud computing as it offers the fundamental infrastructure of virtual servers, network, operating systems and data storage drives. It allows for the flexibility, reliability and scalability that many businesses seek with the cloud, and removes the need for hardware in the office.

Platform as a Service (PaaS). The providers of cloud computing deploy the infrastructure and software framework, but businesses can develop and run their own applications. Web applications can be created quickly and easily via PaaS, and the service is flexible and robust enough to support them.

Software as a Service (SaaS). This cloud computing solution involves the deployment of software over the Internet to various businesses who pay via subscription or a pay-per-use model. SaaS is managed from a central location so



businesses don't have to worry about maintaining it themselves, and is ideal for short-term projects.

4. Cloud computing is increasingly being used to build apps and services, store and manage data, host websites. The most important benefits of cloud computing include:

Cost-efficiency. Cloud computing is probably the most cost-efficient method to use, maintain and upgrade information. The cloud is available at much cheaper rates and hence, can significantly lower the company's IT expenses.

Almost Unlimited Storage. Storing information in the cloud gives almost unlimited storage capacity.

Backup and Recovery. Since all data is stored in the cloud, backing it up and restoring the same is relatively much easier than storing the same on a physical device. Furthermore, most cloud service providers are usually competent enough to handle the recovery of information.

Easy Access to Information and Quick Deployment. You can access the information from anywhere and your entire system can be fully functional in a matter of a few minutes.

5. In spite of its many benefits that are mentioned above cloud computing also has its drawbacks: data privacy and security in the cloud, prone to attack, technical issues. Cloud technology is a rapidly evolving concept which presupposes the future of computing. This technology offers a faster, more secure, reliable, efficient usage – and is fast becoming an alternative to purchasing and upgrading hardware, systems and applications.

(<https://builtin.com/cloud-computing>

<https://www.lifewire.com/cloud-computing-explained-2373125>

<https://www.leadingedgetech.co.uk/it-services/it-consultancy-services/cloud-computing/what-are-the-types-of-cloud-computing>)

II. Define the following statements as true (T) or false (F). Correct the false ones. Find evidence in the text.

1. Cloud computing implies computing services provided via the Internet.
2. Companies delivering cloud services ensure users an access to files and applications stored on remote servers from all places.
3. Hybrid cloud is the typical cloud computing deployment.
4. Scalability and flexibility are important advantages of SaaS.
5. Cloud computing offers practically bottomless storage capacity.
6. Customers are offered an opportunity to rent space on the clouds of the leading cloud providers.
7. Cloud computing doesn't involve the risk of confidentiality of your data and information.
8. Cloud computing is a fast developing technology that can be used as an option for obtaining and improving systems and applications.

III. Complete the following sentences choosing the most suitable variant.

1. The cloud enables users to access various files and applications from almost any device _____.
 - a) with the help of physical hardware;
 - b) through optical cables;
 - c) over the Internet.
2. IaaS supplies IT infrastructure including _____.
 - a) files and documents;
 - b) basic storage, servers and network resources;
 - c) software, hardware and recovery of information.
3. Cloud technology is very cost effective and it _____.
 - a) can greatly reduce business's overheads;
 - b) will extend company's commercial opportunities;
 - c) can affect future company's developments.
4. Cloud computing is an ideal option to _____.
 - a) reduce the use of Internet resources in the company's work;
 - b) increase the cost of buying various types of equipment;
 - c) remove the need to use and update systems and applications.
5. This modern technology provides _____.
 - a) tools for editing various kinds of information;
 - b) limitless possibilities for storing information;
 - c) an opportunity to search for the necessary information.

IV. Read passage 1 and answer the following questions:

1. What services does cloud computing provide?
2. What should every cloud application include?
3. What are the most known hosting companies?

V. Read passage 2 and name the main types of cloud computing and their general characteristics.

VI. In passage 3 find the words or word combinations with a similar meaning to the following ones:

to suggest; to look for; use of an operating program; temporary tasks; diverse; to eliminate the necessity; reliable; basic; to provide; adaptability; typical.

VII. Read passage 4 and list the most important advantages of cloud technology.

VIII. Translate passage 5 into Russian. Find the complex sentences and name their conjunctions.

IX. Make an outline of the text.

X. Speak on:

1. The role of cloud technology in modern world.
2. Main types of cloud computing services.

3. Security problems connected with cloud computing.
4. The future development of cloud technology.

ADDITIONAL ACTIVITY

Complete the crossword using the clues given below.

CROSSWORD PUZZLE ON CLOUD COMPUTING

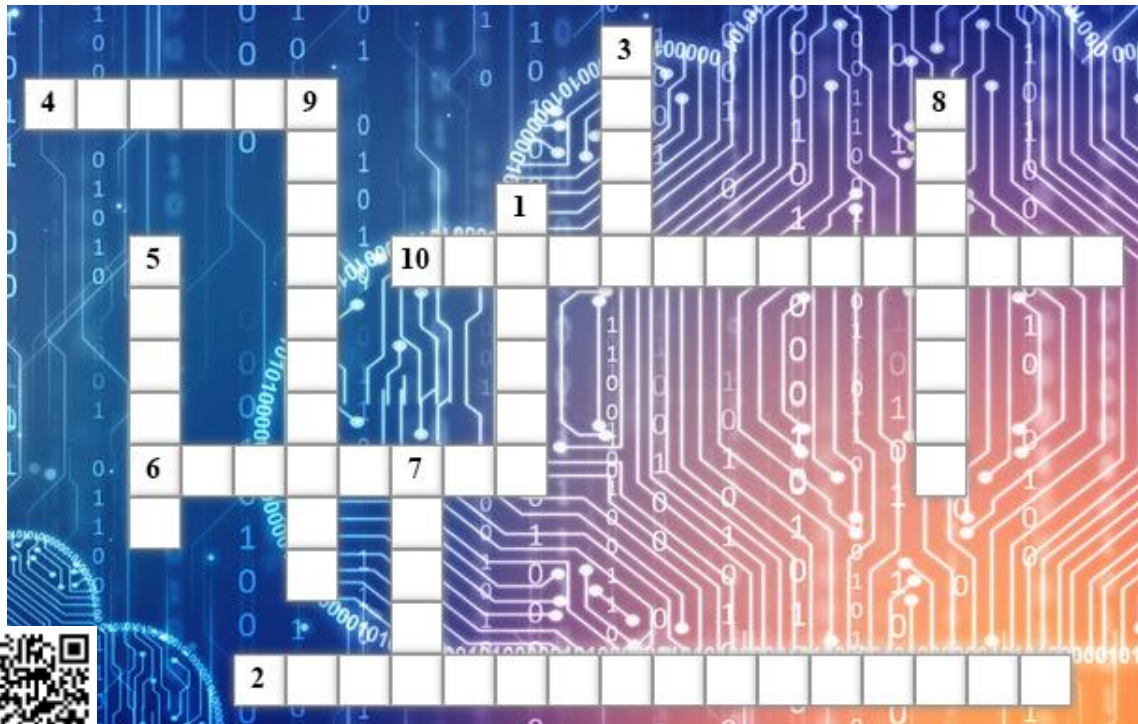

<https://learningapps.org/watch?v=pjk4f04za22>

Across	Down
<p>2. Objects with computing devices in them that are able to connect to each other and exchange data using the Internet.</p> <p>4. A Deployment Model which is a combination of a Private and a Public Cloud.</p> <p>6. Gmail is an example of SaaS. What does the first S stand for?</p> <p>10. Delivers hosted services over the Internet.</p>	<p>1. The Cloud Platform that insurance company has chosen.</p> <p>3. Networked computing facilities providing remote data storage and processing services via the Internet.</p> <p>5. The right or opportunity to use or see something.</p> <p>7. Microsoft's Cloud Computing Service or bright blue in colour like a cloudless sky.</p> <p>8. What does the letter P stand for in PaaS?</p> <p>9. A large group of networked computer servers typically used by organizations for the remote storage, processing, or distribution of large amounts of data.</p>

3.3. Многофункциональные слова Multifunctional Words

3.3.1. Признаки распознавания функций и значений **that (this, these, those)**

1. Союз <i>that</i> + придаточное предложение (С+СК) = <i>что</i> The research has shown that a Web user should be informed of the security measures used by the site.
2. Союзное слово <i>that</i> + сказуемое (СК) = <i>который</i> A device that functions as both a transmitter and a receiver is called a transceiver.
3. Слово-заместитель <i>that/those</i> + of/причастие (Participle II)/прилагательное = <i>переводится существительным, которое оно заменяет</i> This is new measuring equipment, its accuracy is much higher than that of the old one.
4. Указательное местоимение <i>that (this, these, those)</i> + существительное = <i>том, та, то (этом, эти, те)</i> At that time, computers were also becoming an increasingly important scientific tool.

I. Define the functions and meanings of the words in bold. Give their Russian equivalents.

1. Security is a critical issue **that** almost everyone of us deals with. 2. To prove **this** law experimentally is very difficult. 3. The television audio signals are received by equipment similar to **that** used in other forms of radio. 4. **These** projects have not been put into effect yet. 5. The word semiconductor means rather generally a material which has electrical conductivity half-way between **that** of a metallic conductor, and **that** of an insulator. 6. The transistor consists of an emitter **that** supplies electrons, a collector **that** collects the electrons, and a base **that** controls the flow of electrons. 7. Research in **these** fields has led to the development of transistors, ICs, lasers and optical fibres. 8. **These** objects, called applets, follow a set of instructions written by the person **that** programmed the applet.

II. Give the Russian equivalents of the following sentences.

1. These devices are more reliable than those designed in our laboratory. 2. Today's cloud computing infrastructure demonstrates an array of characteristics that have brought meaningful benefits for businesses of all sizes. 3. The robots became so intelligent that they revolted. 4. Natural rubber is of higher quality than that produced artificially. 5. These factors taken together ensure high production efficiency. 6. This scientific discovery was the result of six-year research. 7. Current research in information processing deals with

programs that enable a computer to understand written or spoken information.
8. Organizations that have large amounts of printed information are working to transfer their information into databases.

3.3.2. Признаки распознавания функций и значений *after*

<p>1. Подчинительный союз <i>after</i> + придаточное предложение (С+СК) = <i>после того, как</i> <i>After</i> the new device had been tested it was installed in our laboratory. I found the message <i>after</i> he had left.</p>
<p>2. Предлог <i>after</i> + существительное/местоимение/герундий = <i>после</i> They left the laboratory <i>after</i> finishing the experiment.</p>
<p>3. Наречие <i>after.</i> (конец предложения) = <i>потом, затем</i> In 1948 J. Bardeen and W. Brattain invented the point-contact transistor and W. Shockley invented the junction transistor shortly <i>after</i>.</p>

3.3.3. Признаки распознавания функций и значений *before*

<p>1. Подчинительный союз <i>before</i> + придаточное предложение (С+СК) = <i>до того, как; прежде, чем</i> Many experiments had been made <i>before</i> the scientist succeeded in getting the desired result.</p>
<p>2. Предлог <i>before</i> + существительное/местоимение/герундий = <i>до, перед</i> Each node waits a random time <i>before</i> sending again. <i>Before</i> the advent of the browser the Internet was used mostly for e-mail exchange.</p>
<p>3. Наречие <i>before.</i> (конец предложения) = <i>раньше, прежде</i> Wireless technology provided communication links that had never been possible <i>before</i>.</p>

III. Give the Russian equivalents of the following sentences.

1. On-demand scanners usually detect a virus only after the infection has occurred and that is why they are considered reactive. 2. Devices consisting of solid pieces of crystalline material, which allowed alternating current to flow more readily in one direction than the other, were known long before the invention of the thermionic valve. 3. After transmitting one frame, the sender waits for an acknowledgment before transmitting the next frame. 4. In the field of medicine electronic diagnostic instruments have given physicians a much clearer view of the human body than ever before. 5. Before a switch is added into a network, the VTP management domain should be identified. 6. External memory consists of storage on peripheral devices that are slower than internal memories but offer lower cost and the ability to hold data after the

computer's power has been turned off. 7. The first stage of the project was over and it was decided to start the final one shortly after. 8. More efficient laboratory techniques need to be developed, however, before DNA computing becomes practical. 9. With the small and effective transistor at their hands, electrical engineers of the 1950s saw the possibilities of constructing far more advanced circuits than before. 10. After another stage of amplification the current is strong enough to operate the powerful loud speaker.

3.3.4. Признаки распознавания функций и значений *as*

1. Подчинительный союз

As + придаточное предложение (С+СК) = 1) *так как; поскольку;*
 2) *когда; пока; в то время как;*
 3) *как; также как и; аналогично.*

1) *As* this question is of utmost importance, we will discuss it at once.

2) *As* you walk round a hologram, it changes, as if it were real.

3) Satellite systems do not require the construction of intermediate repeater stations, *as* do ground-based microwave systems.

2. Предлог

As + существительное/местоимение = *как, в качестве*

In a digital signal the information is encoded *as* a set of discrete values.

This gifted scientist works *as* director of the newly established research institute.

Примечание. *As* входит в состав некоторых составных союзов и наречий: *as if* – как будто, *as to* – что касается, относительно, *as though* – как будто, *as for* – что касается, *as long as* – пока, *as soon as* – как только, *as well* – тоже, также, *as well as* – также как и.

IV. Give the Russian equivalents of the following sentences.

1. Meanwhile, mobile communications became the growth driver in telecommunications as millions of people took up the use of portable phones. 2. We tap into the electromagnetic spectrum with our communications devices and use the electromagnetic energy as a communications tool. 3. Because ROM is actually a combination of hardware (microchips) and software (programs), it is often referred to as firmware. 4. The Internet flourished in the late 1980s as most universities and many businesses around the world came online. 5. Changes in a data transmission system often require costly upgrades to expand capacity as well as redesigned equipment. 6. As computers become an increasingly integral part of modern society, computer scientists strive to solve new problems and invent better methods of solving current problems.

3.3.5. Признаки распознавания функций и значений *for*

1. Подчинительный союз

for + придаточное предложение (С+СК) = *так как, потому что; ибо*

The device may be relied upon, *for* it is of the latest design.

2. Предлог

for + местоимение/существительное/герундий = *для, за; в течение*

Computers are essential *for* compiling census data and handling tax records.

Charles Babbage worked on the analytical engine *for* nearly 40 years.

V. Give the Russian equivalents of the following sentences.

1. Users can download, or copy, information from a remote computer to their PCs and workstations for viewing and processing. 2. Each process is typically allowed to use the CPU for a limited time, which may be only a fraction of a second. 3. The experiment was a failure, for the measuring instruments were defective. 4. Alan Turing devised the most famous test for assessing computer intelligence. 5. Computer architecture is concerned with developing optimal hardware for specific computational needs. 6. Some of the atoms in your bones are exploding at all times, for minute amounts of phosphorus in your bones are radioactive. 7. In 1999 the Melissa macro virus, spread by e-mail, disabled e-mail servers around the world for several hours, and in some cases several days.

3.3.6. Признаки распознавания функций и значений *since*

1. Подчинительный союз

since + придаточное предложение (С+СК) = 1) так как;

2) с тех пор, как.

1) *Since* a general solution is quite difficult, various simplifying assumptions are used to represent the system.

2) Mobile telephony has undergone an enormous expansion *since* it was introduced in the late 1970s.

2. Предлог

since + местоимение/существительное = *с, после*

Metrology has existed in some form or another *since* antiquity.

3. Наречие

since. (конец предложения) = *с тех пор*

The popularity of Wi-Fi has grown steadily *since*.

VI. Give the Russian equivalents of the following sentences.

1. Microprocessor applications have grown rapidly since the 1970s. 2. The advent of the Internet and the World Wide Web caused a revolution in the availability of information not seen since the invention of the printing press. 3. Since each particle may be in either of two spin states, or in both, calculations can be simultaneously done for both states. 4. Since the inception of computer memory, the capacity of both internal and external memory devices has grown steadily at a rate that leads to a quadrupling in size every three years. 5. Integrated circuit memory quickly displaced core and has been the dominant technology for internal memory ever since. 6. Since computers have only a limited amount of memory, software designers must limit the number of features they include in a program so that it will not require more memory than the system it is designed for can supply.

VIDEO

«OVERCOMING DATA SECURITY CHALLENGES IN THE CLOUD WORLD», 3:57

(<https://www.youtube.com/watch?v=55jdSe7Ro68>)



I. Before watching the video, study the words which will help you understand the speaker. Match the words with the definitions.

- | | |
|-------------------|---|
| 1) implementation | a) the action of making something possible; |
| 2) data residency | b) matter for consideration; |
| 3) to shift | c) to succeed in doing or dealing with something difficult; |
| 4) enablement | d) a piece of data that stands in for another, more valuable piece of information; |
| 5) oversight | e) someone who keeps and protects something valuable; |
| 6) data breach | f) watchful care or management; supervision; |
| 7) to manage | g) the physical or geographic location of an organization's data or information; |
| 8) custodian | h) to move or to cause to move from one place to another one; |
| 9) concern | i) an unauthorized access and retrieval of sensitive information by an individual, group, or software system; |
| 10) token | j) the act of fulfillment. |

II. In pairs, discuss the following questions.

1. What are the main problems of storing information in the cloud?
2. How can data security issues be overcome?
3. What is tokenization?

III. Watch the video and check if you were right.

IV. Watch the video again and define the following statements as true (T) or false (F). Correct the false ones.

1. As cloud computing is getting increasingly popular among many businesses, security problems have become a growing concern.
2. Due to cloud technology the expenses of different organizations have been significantly decreased.
3. Data security is the only crucial issue businesses can face moving to the cloud.
4. Data encryption is the conversion of data from a readable format into an encoded one that can only be decrypted by a person with the secret key.
5. Tokenization secures information from various types of threats.

V. Give an explanation of the major differences between tokenization and encryption.

VI. Name the opportunities that one of the leading consulting companies Capgemini offers to different organizations.

VII. Express your point of view on the solutions suggested by Capgemini. Do you think they will be effective for data security and data loss prevention? Justify your opinion.

GRAMMAR FOCUS 3

3.4. Бессоюзное подчинение Conjunctionless Subordination

3.4.1. Определительное бессоюзное предложение

1.	главное предложение (C+СК)	придаточное предложение (C+СК)		
Fiber-optic cables use repeaters to avoid losing the light signals (<i>which/that</i>) they carry.		Волоконно-оптические кабели используют ретрансляторы, чтобы избежать потери световых сигналов, <i>которые</i> они передают.		
2.	C1 (субъект или его группа) главного предложения	C2 (субъект или его группа) определительного	СК2 сказуемое придаточного определительного	СК1 сказуемое главного предложения
The software (<i>that/which</i>) you are using is developed by Microsoft.		Программа, <i>которую</i> ты используешь, написана Microsoft.		
3.	главное предложение (C+СК)	придаточное предложение (C+СК)	предлог ¹	
This is a problem (<i>which</i>) we will spend much time <i>on</i> .		Это проблема, <i>на которую</i> мы потратим много времени.		

¹ Перед союзным словом может стоять предлог. Если союзное слово опускается, предлог выносится в конец придаточного предложения.

3.4.2. Условное бессоюзное предложение

<i>Should</i> (<i>could, were, had</i>)	C (субъект или его группа)	продолжение придаточного предложения	главное предложение
--	----------------------------	--------------------------------------	---------------------

- a) *Should* he come, we'll discuss this problem.
(*If* he should come we ...)
- b) *Had* they the necessary material they would finish the work in time.
(*Provided* they had ... they ...)
- Если* он придет, мы обсудим эту проблему.
- Если бы (при условии, что)* у них был весь необходимый материал, они закончили бы работу вовремя.

3.4.3. Дополнительное бессоюзное предложение

главное предложение (С+СК)	придаточное предложение (С+СК)
-------------------------------	-----------------------------------

 .

We are sure (*that*) it is possible to change the conditions. Мы уверены, *что* возможно изменить условия.

I. Define the type of a conjunctionless complex sentence.

1. The equipment the first computers were made of had not been accurate and reliable. 2. Should confidential information about a business' customers or finances or new product line fall into the hands of a competitor, such a breach of security could lead to lost business, law suits or even bankruptcy of the business. 3. Medium assurance suggests it can protect less valuable information, such as income tax information. 4. Had we applied this method of work, we should have had the desired results. 5. The designer said advances in display technology will help spur adoption as color screens become more suitable for TV-quality images. 6. A distribution is a complete operating system kit with the utilities and applications you need to make it do useful things.

II. Give the Russian equivalents of the following sentences.

1. Such guidelines are extremely effective as they lead the visitors through the site content in a very simple and user-friendly way. 2. As the Web is different from print, it's necessary to adjust the writing style to users' preferences and browsing habits. 3. After you've worked on a site for a few weeks, you can't observe it from a fresh perspective anymore. 4. Should one computer fall, the other takes over its function. 5. Either you'll be pointed to the problems you have or you'll be pointed to the absence of major design flaws, which is in both cases a useful insight for your project. 6. Time users waste being lost on your intranet is money you waste by paying the employees to be at work without getting work done. 7. To increase programming efficiency and simplify use, however, most programs are written in a high-level language which uses commands based on words and mathematical notation. 8. The main reason people and businesses are switching over to VoIP is because of the significant cost savings that can be made over a traditional service provider.

READING 3

I. Read the title of the text and name its main theme.

II. Look through the first paragraph of the text. What is the main purpose of cyber security?

CYBER SECURITY

1. A Cyber Security Software is a must for cyber security and privacy of a business or individual. Cyber security is the method that is used to protect the network, system, or applications from the cyber attacks. It needs to be maintained for various

types of cyber threats like Ransomware, Malware, Social Engineering, and Phishing. To maintain effective cybersecurity, there are certain steps to be followed, i.e. updating software or systems, conducting security audits from top to bottom, social engineering audits, regular data backups at work, and maintaining physical security and industry compliance.



2. The most popular cyber security tools that are used for small to medium-sized organizations worldwide are enlisted below:



Norton. This paid program stands out as the best antivirus in 2021 with its powerful security and high-performing features. It includes the best scanning and real-time protection rates, generous cloud storage, and an unlimited data VPN (Virtual Private Network).



Total AV antivirus. It is a free cybersecurity software tool that offers complete security for all your household devices.



Solar Winds Security Event Manager. This system performs real-time monitoring, responding, and reporting of security threats. It is a cloud-based scalable solution.



Bitdefender. This antivirus provides a well-rounded antivirus suite for beginners and advanced users alike. It has a combination of near-perfect detection rates and actually useful features to complement your device security in multiple ways.



Malwarebytes. It presents the cybersecurity solution for home and businesses. It can prevent threats in real time and defend against harmful sites.



Panda. It is a powerful antivirus for core malware protection, with the addition of a few unique and expected features fleshing it out.

3. It's crucial to find a trustworthy free antivirus as the majority on the Internet are actually malware in disguise. Luckily, many of the best (paid) antiviruses also have a free version, including Bitdefender, Panda and Malwarebytes. This means you can enjoy powerful malware protection at no cost. However, keep in mind that every free version does come with some limitations. This ranges from restrictions on bundled features (like a VPN or password manager) to zero protection against complex forms of malware.

4. The following four steps will make your own computer a much harder target for threats:

Running a personal Firewall. A personal firewall is software that basically makes your computer invisible to hackers, worms and other threats that can infect your computer over the Internet.

Turn on Windows Updates. These updates will keep your computer running better, and they often fix security issues that could compromise your information or privacy.

Install and update Antivirus software. No matter what program you have, you will need to update it when you get connected to the Internet.

Install Anti-spyware software. It always runs in the background and will automatically catch a lot of spyware before it gets on your computer.

5. In this age of accelerated digital transformation, cybercriminals are constantly looking for new ways to target and cause harm to individuals and organizations, which means cyber security issues continue to evolve. Using a high-quality antivirus software will help you stay safe in the face of the latest cyber threat trends.

(<https://www.softwaretestinghelp.com/cybersecurity-software-tools>
<https://www.wizcase.com/anti-virus>)

III. Read the text and match the pictures with the name of the cyber security tool. Give brief characteristics of each tool.

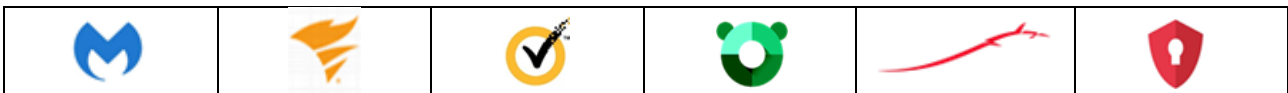

a) Total AV antivirus	b) Bitdefender	c) Panda	d) Malwarebytes
e) Norton	f) Solar Winds Security Event Manager		

IV. Read the text and decide which of these statements correspond to the content of the text.

1. Any organization that uses modern technology must be aware how to reduce the risk of cyber attacks.
2. Norton Antivirus Software ensures effective protection against multiple online threats.
3. Deleteme is an easy-to-use cyber security solution to remove your personal information.
4. A lot of well-known paid antivirus tools offer more features than their free counterparts.
5. The growing use of IoT (Internet of Things) devices means that business may need multiple solutions to secure and protect these devices.
6. Virtual Private Networks protect data by connecting it through an encrypted tunnel to a remote server.

V. Find the passage containing the information about different kinds of cyber threats users can face and name them.

VI. In the text find the measures to be taken in order to protect your computer from cyber attacks. Which of them do you think provide the best antivirus protection? Which of them do you use? Express some more ideas how to keep the computer safe.

VII. You are a security specialist. Your task is to inform novice computer users about the importance of cyber security and the most reliable antivirus software available now. Give the main points in 5-6 sentences.

SUMMARY WRITING

I. Read the article and write a short summary of it.

TOP IoT TRENDS AND PREDICTIONS TO LOOK OUT FOR IN 2022

by Sayantani Sanyal

Internet of Things (IoT) is a popular topic for discussion among individuals working in the tech and in the manufacturing industry. IoT is a hyped-up futuristic technology and is also known for its social and technological wonders. The latest IoT trends can attest to the fact that this technology has revolutionized several industries. It has helped businesses improve processes, boost earnings, and provide better customer services. IoT and its smart sensors have already paved the way for automation enhancements in different sectors, along with the increasing use of the cloud and the development of 5G. The emerging trends in IoT are majorly driven by artificial intelligence, edge computing, blockchain, and others. This article talks about some of the top trends and predictions of IoT that will change the tech world in 2022.

Advanced Security

The IoT market will witness a renewed focus on security. Experts believe that by 2022, IoT network hacking will become a common phenomenon. Network operators will act as cybersecurity personnel and prevent intruders from causing any harm. Since cyberattacks have become so common lately, companies like Sierra, Wireless, and others who have been cyber-attacked previously have adopted IoT-driven cyber tools. Other companies, like Ericsson, Microsoft, and U-Blox, have come up with their own threat detection and security service tools.



Analytics, Machine Learning, other Disruptive Technologies

IoT analytics and data are detecting applications in IoT networks. These systems trigger alerts while transferring volumes of data to the network cores. Integrated analytics are now being deployed into solutions as providers and business leaders want to accelerate data analysis. These systems support IoT devices, processes, applications, and infrastructure adoption and optimization, ensuring improved performances as networks operate in a low latency environment.

IoT Transforming Business Models

There are several proofs, reports, and examples of the successful implementation of IoT in business models, where it has enhanced the performance of the company by increasing its output and by improving other business metrics and objectives. With the help of automation, manufacturers are transforming their entire business models into more innovative and productive ones.

AR and VR with IoT

Virtual and augmented reality with IoT can bind together the physical and the digital worlds. It brings in an opportunity for the application of IoT data in AR and VR technologies. Implementing IoT in these technologies brings economic benefits like reduced costs and several new and increased profits and opportunities. Combining these technologies might help companies educate employees about the virtual prototypes of products, types of equipment and can also help contemplate various strategies to determine business growth.

Adoption of IoT in Healthcare

The healthcare industry has been experimenting with IoT technologies for years now. This industry is leading in IoT adoption and innovation. Different types of equipment like wearable sensors and devices, tracking, and indoor navigation tech are discovered using IoT. It can also

enhance lighting systems by linking them to health monitors and deploying sensors.

The Emergence of Smart Cities

The establishment of smart cities will be the result of IoT and edge computing technologies. Experts are discussing the next innovations in smart digital connectivity. Some cities in the United States are already contemplating connecting utilities, parking meters, and traffic lights to IoT networks. Smart cities will not only improve the social living standards but will also benefit citizens from economic aspects.

Boost in Customer Service

IoT technologies have massively impacted customer services providing information. IoT can improve the power of CRM systems, which helps them to detect customer problems and report them to the companies. These systems even allow the companies to join customer discussions for improved consumer engagement, which eventually leads to customer retention.

(Analytics Insight, 23 September 2021)

(<https://www.analyticsinsight.net/top-iot-trends-and-predictions-to-look-out-for-in-2022>)

FOLLOW UP

I. In small groups, read and comment on the following quotes. Think about the reasons for or against each point of view.



«We are moving slowly into an era where Big Data is the starting point, not the end». *Pearl Zhu*



«As the Internet of things advances, the very notion of a clear dividing line between reality and virtual reality becomes blurred, sometimes in creative ways». *Geoff Mulgan*

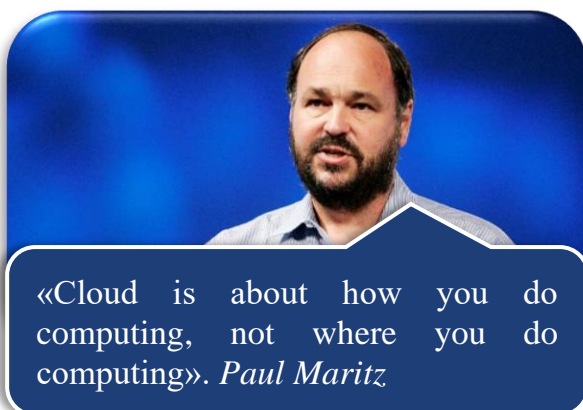

II. You are taking part in a round-table discussion on the theme «Modern Information Technologies in my Life». You will talk for about 2 minutes. Think it over and make notes of the main points if necessary.

These phrases might help you:

- In my opinion _____.
- From my point of view _____.
- I am sure/convinced that _____.
- I think/believe/suppose _____.

III. Role play the following situation in pairs.

Student A

You are a leading specialist in IT company. You are looking for a person for your team for doing the project concerning data storage. Ask some specific questions about cloud computing, data encryption and cyber security. Inform team members about your decision.

Student B

Your dream is to work in IT company dealing with information storage software. Be ready to answer the questions concerning cloud computing, data encryption and cyber security. Do your best to make a good impression and be accepted for this position.

IV. The company you are working for has informed the staff about the international webinar with e-certificates on the theme «The Diversity of Information Technologies». You have decided to take advantage of this opportunity and make a presentation (6–8 slides) on one of the directions suggested by the organizers of the webinar.

- Best OS for Software Engineers.
- The Top Programming Languages.
- New Trends in Programming.
- Modern Data Storage Technologies.
- Cyber Security Challenges and Solutions.
- Benefits of IoT in our Lives.

Present your ideas to the participants of the webinar. Be ready to answer the questions in the follow-up discussion.

MODULE 4

ARTIFICIAL INTELLIGENCE

Grammar: PARTICIPIAL, GERUNDIAL AND INFINITIVE CONSTRUCTIONS

PART I

BASIC AI CONCEPTS

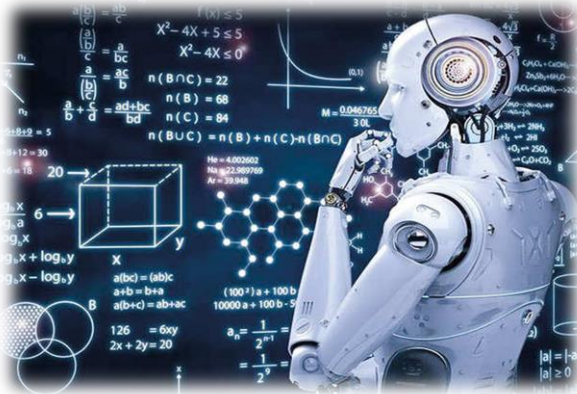

«Our **INTELLIGENCE** is what makes us human, and AI is an extension of that **QUALITY**».

Yann LeCun

STARTING UP

I. Do you know what Artificial Intelligence (AI) is? Look at the picture, read the quote and share your ideas with a partner.

II. Among the following definitions identify the one that implies the meaning of AI. What do the other definitions mean?

1. An international computer network connecting other networks and computers from companies, universities, etc.
2. An area of study concerned with making computers copy intelligent human behaviour.
3. The programs, etc. used to operate a computer.
4. The process of writing and testing programs for a computer.

III. Do the quiz to check your knowledge about AI.

1. When was the term «Artificial Intelligence» coined?
A. 1930s. **B.** 1960s. **C.** 1990s. **D.** 2000s.
2. Which key technology is behind Artificial Intelligence?
A. Machine Learning. **B.** Robotics. **C.** Electric Battery. **D.** Blockchain.
3. How is Artificial Intelligence developed further and how are errors in the AI system corrected?
A. Through a faster Internet connection.
B. A further development is not possible with these systems, since they are ready-made programs.
C. Through higher storage capacities of the computers.
D. By learning: by the user giving feedback and making corrections to the AI.

4. What types of Artificial Intelligence are there?
- Supervised, Unsupervised and Reinforcement Learning.
 - Monitored, Unsupervised and Signal Learning.
 - Signal Learning, Concept Learning and Rule Learning.
 - Reinforcement Learning, Unsupervised Learning and Signal Learning.
5. Which method is used by Reinforcement Learning in order to independently find solutions to defined problems?
- Trial and error method to maximize punishment.
 - Trial and error method to maximize rewards.
 - Trial and error method to maximize error messages.
 - Trial and error method to minimize rewards.
6. In which of the following areas does the use of Artificial Intelligence result in an added value for society?
- Traffic.
 - Medicine.
 - Education.
 - All.
7. Which of the following tasks could most likely be performed by Artificial Intelligence?
- The personal implementation of consultation appointments with doctors.
 - The complete replacement of a doctor in the treatment of patients.
 - The analysis of X-ray images, for example to detect a torn meniscus or a tumor.
 - The implementation of psychotherapies.
8. Which of the following aspects is essential to ensure a sustainable and safe application of Artificial Intelligence?
- The use of AI must be in line with social values and laws such as ethics and data protection.
 - The use of AI must be ensured by more cars for autonomous driving.
 - The use of AI must be ensured through more memory and performance capacities on smartphones and computers.
 - The use of AI requires a better understanding and more openness of the population.
9. Which of the following points is often referred to by society as a risk of Artificial Intelligence?
- Climate change.
 - New diseases.
 - Job losses.
 - Political unrest.
10. Which of the following attributes can currently not be mapped by Artificial Intelligence?
- Intuition.
 - Creativity.
 - Empathy.
 - All three: intuition, creativity, empathy.

(<https://www.rolandberger.com/en/Insights/Publications/The-Artificial-Intelligence-Quiz-Test-Your-Knowledge.html#!/%23quiz>)

IV. Discuss these questions in groups.

- What is the impact of AI on society?
- Will machines become super-intelligent and will humans lose control?
- What are unforeseen consequences when a new technology is introduced?

READING 1

I. Read the title of the text. Guess if the following statements are true (T) or false (F). Share your ideas with a partner.

1. Some basics of the theory of natural selection are applied in AI research.
2. AI systems are able to show few intellectual skills typical of a human.
3. A modern concept of AI presupposes that it can't implement accumulated data in unknown range of possible options.

II. Read the text and check if you were right.

III. Five sentences have been removed from the text. Choose from the sentences A–F the one which fits each gap 1–5. There is one extra sentence which you don't need to use.

A. A case in point is self-driving cars, which themselves are underpinned by AI-powered systems such as computer vision.

B. At a very high level, artificial intelligence can be split into two broad types.

C. «Intelligence is the efficiency with which you acquire new skills at tasks you didn't previously prepare for», he said.

D. This is the sort of AI more commonly seen in movies, the likes of HAL in 2001 or Skynet in The Terminator, but which doesn't exist today – and AI experts are fiercely divided over how soon it will become a reality.

E. Unlike humans, these systems can only learn or be taught how to do defined tasks, which is why they are called narrow AI.

F. That's obviously a fairly broad definition, which is why you will sometimes see arguments over whether something is truly AI or not.

IV. Read the text again and write out key words and phrases revealing the content of the text.

V. Divide the text into logical parts. In each part find the topical sentence.

THE GENERAL CONCEPT OF AI

Back in the 1950s, the fathers of the field, Minsky and McCarthy, described artificial intelligence as any task performed by a machine that would have previously been considered to require human intelligence.

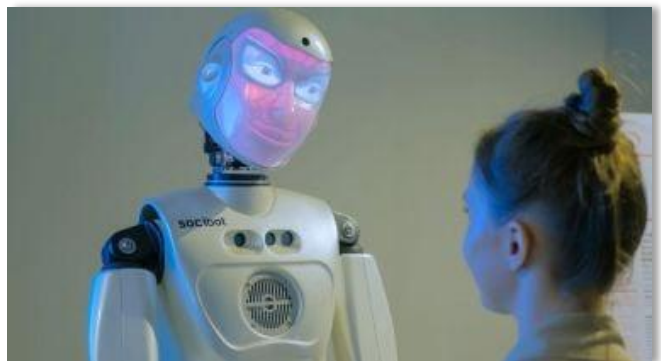

1

Modern definitions of what it means to create intelligence are more specific. Francois Chollet, an AI researcher at Google and creator of the machine-learning software library Keras, has said intelligence is tied to a system's ability to adapt and improvise in a new environment, to generalise its knowledge and apply it to unfamiliar scenarios.

2

It's a definition under which modern AI-powered systems, such as virtual assistants, would be characterised as having demonstrated «narrow AI», the ability to generalise their training when carrying out a limited set of tasks, such as speech recognition or computer vision.

Typically, AI systems demonstrate at least some of the following behaviours associated with human intelligence: planning, learning, reasoning, problem-solving, knowledge representation, perception, motion, and manipulation and, to a lesser extent, social intelligence and creativity.

AI is ubiquitous today, used to recommend what you should buy next online, to understand what you say to virtual assistants, such as Amazon's Alexa and Apple's Siri, to recognise who and what is in a photo, spot spam, or detect credit card fraud.

3

Narrow AI

Narrow AI is what we see all around us in computers today – intelligent systems that have been taught or have learned how to carry out specific tasks without being explicitly programmed how to do so.

This type of machine intelligence is evident in the speech and language recognition of the Siri virtual assistant on the Apple iPhone, in the vision-recognition systems on self-driving cars, or in the recommendation engines that suggest products you might like based on what you bought in the past.

4

General AI

General AI is very different and is the type of adaptable intellect found in humans, a flexible form of intelligence capable of learning how to carry out vastly different tasks, anything from haircutting to building spreadsheets or reasoning about a wide variety of topics based on its accumulated experience.

5

Another area of AI research is evolutionary computation. It borrows from Darwin's theory of natural selection. It sees genetic algorithms undergo random mutations and combinations between generations in an attempt to evolve the optimal solution to a given problem.

This approach has even been used to help design AI models, effectively using AI to help build AI. This use of evolutionary algorithms to optimize neural networks is called neuroevolution. It could have an important role to play in helping design efficient AI as the use of intelligent systems becomes more prevalent, particularly as demand for data scientists often outstrips supply. The technique was showcased by

Uber AI Labs, which released papers on using genetic algorithms to train deep neural networks for reinforcement learning problems.

Finally, there are expert systems, where computers are programmed with rules that allow them to take a series of decisions based on a large number of inputs, allowing that machine to mimic the behaviour of a human expert in a specific domain. An example of these knowledge-based systems might be an autopilot system flying a plane.

(<https://www.zdnet.com/article/what-is-ai-heres-everything-you-need-to-know-about-artificial-intelligence>)

Notes:

- *to outstrip* – to move faster than and overtake (someone else);
- *to showcase* – to exhibit; to display;
- *to mimic* – to imitate.

VI. Decide which of these statements correspond to the content of the text.

1. Emotional AI is a subset of artificial intelligence that measures, understands, simulates, and reacts to human emotions.
2. AI is assumed to have some features which human intelligence does.
3. Narrow AI systems are able to perform tasks not being specially programmed to fulfil them.
4. General AI is capable of learning how to do immensely various tasks using its stored practical knowledge.
5. General AI will be introduced in different systems in a few decades.
6. Evolutionary computation approach presupposes the use of neural nets suited to speech recognition.

VII. In the text find the sentences containing:

- a) older and modern definitions of AI;
- b) distinctive features between narrow and general AI;
- c) the reasons why neuroevolution is significant in designing efficient AI.

VIII. Describe the systems which make it possible to imitate human's conduct in a particular area.

IX. Express your attitude to the facts given in the text. Use the following phrases:

- It is full of interesting information.
- I find the text rather interesting/ cognitive because _____.
- I've learnt a lot about _____.
- I don't agree with _____, because _____.

X. Sum up the text using key words, word combinations and topical sentences.

XI. Say what new information about AI you have learnt from the text. Do you think it will be useful in your future professional activities?

4.1. Причастные обороты

4.1.1. Признаки распознавания причастных оборотов с причастием I

<p>the x xing + зависимые слова</p> <p style="text-align: center;">↓</p> <p>после существительного</p>	<p>ОПРЕДЕЛИТЕЛЬНЫЙ</p> <p>причастный оборот</p>	<p>делающий</p> <p>(-ущ, -ющ, -ащ, -ящ, -вш, -ш), <i>придаточным предложением</i></p>
---	--	--

The tube **consisting of a cathode, a control grid and a plate** is a triode.

Лампа, *состоящая из катода, управляющей сетки и анода*, является триодом.

<p>Xing + зависимые слова</p> <p style="text-align: center;">↓</p> <p>- в начале предложения перед подлежащим; - в конце предложения (... xing + зависимые слова); - может вводиться союзами <i>when</i> «когда» и <i>while</i> «в то время как».</p>	<p>ОБСТОЯТЕЛЬСТВЕННЫЙ</p> <p>причастный оборот</p>	<p>делая</p> <p>(-а, -я, -ав, -ив); <i>придаточным предложением;</i> при + <i>существительное</i></p>
---	---	---

Developing a new semiconductor device, the scientist solved many problems.

Разрабатывая новое полупроводниковое устройство, ученый решил многие проблемы.

He will achieve success *working hard*.

Он добьется успеха, *упорно работая*.

While conducting space research, scientists discovered the nuclei of antimatter.

Проводя космические исследования, ученые открыли ядра антивещества.

4.1.2. Обстоятельственные причастные обороты с причастием I пассивным

<p>Being xed + зависимые слова</p> <p style="text-align: center;">↓</p> <p>в начале предложения перед подлежащим</p>	<p>ОБСТОЯТЕЛЬСТВЕННЫЙ</p> <p>причастный оборот</p>	<p><i>будучи сделан, когда делается</i></p>
---	---	---

Being built of coloured stone the cinema will look fine.

Так как кинотеатр строится из цветного камня, он будет выглядеть красиво.

4.1.3. Обстоятельственные причастные обороты с причастием I перфектным активным

<p>Having xed + зависимые слова</p> <p style="text-align: center;">↓</p> <p>- в начале предложения перед подлежащим; - в конце предложения.</p>	<p>ОБСТОЯТЕЛЬСТВЕННЫЙ причастный оборот</p>	<p>сделав (-ав, -яв, -ив, -вшишь)</p>
--	--	--

Having repaired the engine the mechanic showed it to the engineer. *Отремонтировав мотор,* механик показал его инженеру.

4.1.4. Обстоятельственные причастные обороты с причастием I перфектным пассивным

<p>Having been xed + зависимые слова</p> <p style="text-align: center;">↓</p> <p>- в начале предложения перед подлежащим; - ... having been xed ...; - в конце предложения.</p>	<p>ОБСТОЯТЕЛЬСТВЕННЫЙ причастный оборот</p>	<p>придаточным предложением с союзами так как, после того как, когда был сделан</p>
---	--	--

Having been repaired properly the engine began operating better. *После того как мотор был отремонтирован должным образом,* он стал работать лучше.

I. Find the attributive and adverbial participial constructions with Participle I. Give their features and Russian equivalents.

1. Qualitative research has many uses, including exploring alternative communication messages and identifying strengths and weaknesses. 2. A backbone is a network transmission path handling major data traffic. 3. The ability of tiny computer devices to control complex operations has transformed the way many tasks are performed, ranging from scientific research to producing consumer products. 4. A router is a special computer directing messages when several networks are linked. 5. The Tor Project offers a channel for people wanting to route their online communications anonymously. 6. Users wishing to take part in the project, need to be subscribed to the Amazon service. 7. There have already been prototypes, attracting crowds at gadget shows.

II. Compare the form and meaning of the participles in the following attributive and adverbial constructions. Define their similarity and difference. Suggest whether this difference influences their meaning.

1. Having changed the program the robot's arm began to perform a new operation. 2. Having studied all the known elements he drew up a table of elements. 3. Having been employed in many industrial processes electronic computers show a notable example of progress contributing to the development of industry. 4. Having

determined the number of amperes and the number of volts, we can find the resistance of the coil by using Ohm's law. 5. Having lost electrons, the atom of the metal is pacifier. 6. The source code of the malware program has become available online, allowing experts to analyze its complicated design. 7. Having analyzed the situation he managed to carry out the experiment. 8. Having been carefully tested the device was put into operation.

WORD FORMATION

I. State the differences of the following words. Explain how these differences affect their meanings.

Consumption – consumer; composition – composer; performance – performer; feed – feeder; recreate – recreation; creation – creator; converse – conversation; associate – association; expression – expressiveness; development – developer; generation – generator.

II. Compare the words by form and choose: a) nouns; b) verbs; c) adjectives; d) adverbs.

Increasingly; array; composer; composition; recreate; network; indistinguishable; humanoid; realistic; gesture; version; associate; revolutionize; personalize; surrender; search; narrow; eventually; automate; envision.

III. Choose an appropriate word and complete the sentences given below.

a) program, programmer, programmable

1. A MICROSOFT-owned tool powered by artificial intelligence is designed to make life easier for a _____.

2. The next evolutionary stage of technology depends on completing the transformation that will make silicon architecture as flexible, efficient and ultimately _____ as the software we know today.

3. The authorities are mounting a nationwide _____ to connect CCTV across the country to facial recognition and to use AI systems to track suspects and suspicious behaviour.

b) behavioural, misbehaviour, behaviour

1. As soon as you have a better overview of the overall situation, you get a much better idea of how to change individual _____.

2. AI helps his team understand exactly why people act; and once the _____ mechanisms of customers are crystal clear, it becomes possible to influence their buying decision.

3. This monitoring deficiency can result in the occurrence of _____, which is one of the most serious yet underestimated security threats facing SoSs (System-of-Systems) and their components.

c) processor(s), processing, process

1. To win the show, Watson used natural language _____ and analytics on vast repositories of data.

2. Google refined the training _____ with AlphaGo Zero, a system that played «completely random» games against itself and then learned from it.

3. The purpose-built graphics _____ proved to be more useful than CPUs for deep learning functions, and the GPU became one of the key players in modern AI and ML.

d) perform, performable, performance

1. Modern narrow AI systems are sometimes capable of superhuman _____, in some instances even demonstrating superior creativity, a trait often held up as intrinsically human.

2. They _____ small pilot projects and proofs of concept before proceeding with full implementation for 64% of respondents.

3. The result proves that the design scheme is highly effective and _____.

IV. Complete this text with the correct form of the words given in capitals at the end of the sentences.

Many of us already live with AI, an array of unseen algorithms that control our Internet-connected devices, from smartphones to **1.** _____ cameras and cars that heat the seats before you've even stepped out of the house on a frigid morning.

SECURE

But, while we've seen the AI sun, we have yet to see it truly shine.

2. _____ liken the current state of the technology to cellphones of the 1990s: **3.** _____, but crude and cumbersome. They are working on distilling the largest, most **4.** _____ machine-learning models into lightweight software that can run on «the edge», meaning small devices such as kitchen **5.** _____ or wearables. Our lives will **6.** _____ be interwoven with brilliant threads of AI.

**RESEARCH
USE
POWER**

Our **7.** _____ with the technology will become increasingly personalized. Chatbots, for example, can be clumsy and frustrating today, but they will **8.** _____ become truly conversational, learning our habits and personalities and even develop personalities of their own.

**APPLY
GRADUAL
INTERACT
EVENTUAL**

WORD STUDY

I. Match the words to the definitions.

1) internalize, *verb*

2) string, *noun*

3) start-up, *noun*

4) fake, *noun*

5) transpose, *verb*

6) relevant, *adjective*

7) interact, *verb*

a) a linear sequence of characters, words, or other data;

b) a pretense or trick;

c) make (attitudes or behavior) part of one's nature by learning or unconscious assimilation;

d) closely connected or appropriate to the matter at hand;

e) chiefly a university or college teacher responsible for the teaching and supervision of assigned students;

8) tutor, *noun*

f) transfer to a different place or context;

g) a newly established business;

h) act in such a way as to have an effect on another; act reciprocally.

II. Match the words to the ones with a similar meaning.

1) indistinguishable

a) rule

2) array

b) indiscernible

3) performer

c) set

4) to blend

d) to gather

5) eventually

e) accessible

6) to catch up

f) artist

7) available

g) to mix

8) to pick

h) to overtake

9) regulation

i) ultimately

III. Replace the words in bold with the similar ones from the box.

a) lines

b) incarnated

c) instructing

d) transfer

e) keep

f) occupies

g) communicate

1. Modern technologies **transpose** appearance and voice of one man onto a video of another one.

2. Scientists are designing **tutoring** systems that can observe students' behavior.

3. AI tutors **hold** the promise of highly individualized education for everyone who has access to the Internet.

4. Developing software tests **takes up** approximately one third of human specialists' time.

5. **Strings** of computer code comprise networks of artificial intelligence.

6. Sometimes one can fancy AI **embodied** in realistic avatars of people.

7. Developers are trying to mix the technologies to generate avatars of people who can **interact** in real time.

IV. Choose the most suitable word or phrase in bold in each sentence.

1. Artificial intelligence can be divided into two general types with their **strengths/powers** and weaknesses.

2. The system uses powerful neural **circuits/networks** developed by Open AI to solve programming problems.

3. The neural network can be taught how **to carry out/produce** a particular task.

4. Such systems allow the computers **to admit/take** a series of decisions based on a large amount of data.

5. This approach has even been **lent/borrowed** from Darwin's theory to help design AI models.

6. Such networks are particularly well **approached/suited** to understanding the meaning of the text and speech recognition.

READING 2

1. Read the text and name the key points raised in it.

1. Increasingly, more of the media we consume will actually be generated by AI. Google's open-source Magenta project has created an array of applications that makes music indistinguishable from human composers and performers. The research institute OpenAI has created MuseNet, which uses artificial intelligence to blend different styles of music into new compositions. The institute also has Jukebox, which

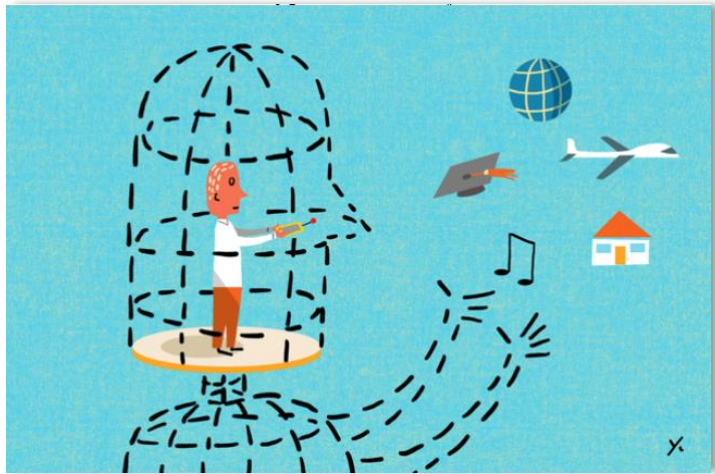

creates new songs when given a genre, artist and lyrics, which in some cases are co-written by AI. These are early efforts, achieved by feeding millions of songs into networks of artificial neurons, made from strings of computer code, until they internalize patterns of melody and harmony, and can recreate the sound of instruments and voices. Musicians are experimenting with these tools today and a few start-ups are already offering AI-generated background music for podcasts and video games.

2. Artificial intelligence is as abstract as thought, written in computer code, but people imagine AI embodied in humanoid form. Robotic hardware has a lot of catching up to do, however. Realistic, AI-generated avatars will have AI-generated conversations and sing AI-generated songs, and even teach our children. Deep fakes also exist, where the face and voice of one person, for example, is transposed onto a video of another one. We've also seen realistic AI-generated faces of people who don't exist.

3. Researchers are working on combining the technologies to create realistic 2D avatars of people who can interact in real time, showing emotion and making context-relevant gestures. A Samsung-associated company called Neon has introduced an early version of such avatars, though the technology has a long way to go before it is practical to use. Such avatars could help revolutionize education. Artificial intelligence researchers are already developing AI tutoring systems that can track student behavior, predict their performance and deliver content and strategies to both improve that performance and prevent students from losing interest. AI tutors hold the promise of truly personalized education available to anyone in the world with an Internet-connected device – provided they are willing to surrender some privacy. «Having a visual interaction with a face that expresses emotions, that expresses support, is very important for teachers», said Yoshua Bengio, a professor at the University of Montreal and the founder of Mila, an artificial intelligence research institute. Korbit, a company founded by one of his students, Iulian Serban, and Riid, based in South Korea, are

already using this technology in education, though Mr. Bengio says it may be a decade or more before such tutors have natural language fluidity and semantic understanding.

4. There are seemingly endless ways in which artificial intelligence is beginning to touch our lives, from discovering new materials to new drugs – AI has already played a role in the development of vaccines by narrowing the field of possibilities for scientists to search – to picking the fruit we eat and sorting the garbage we throw away. Self-driving cars work, they're just waiting for laws and regulations to catch up with them. Artificial intelligence is even starting to write software and may eventually write more complex AI. Diffblue, a start-up out of Oxford University, has an AI system that automates the writing of software tests, a task that takes up as much as a third of expensive developers' time. Justin Gottschlich, who runs the machine programming research group at Intel Labs, envisions a day when anyone can create software simply by telling an AI system clearly what they want the software to do. «I can imagine people like my mom creating software», he said, «even though she can't write a line of code».

(<https://www.nytimes.com/2021/02/23/technology/ai-innovation-privacy-seniors-education.html>)

II. Define the following statements as true (T) or false (F). Correct the false ones. Find evidence in the text.

1. Nowadays pieces of music produced by composers and musicians differ from those made by AI.

2. Some modern artists take advantage of new opportunities of AI to provide an unobtrusive accompaniment for audiocasts and computer games.

3. People can be deceived viewing the face and the voice of one person transferred to a video of another one.

4. Experiments are being made to design artificial copies of people being able to talk, display feelings and proper gesticulation.

5. Modern developments of AI tutors guarantee that one's privacy won't be invaded.

III. Complete the following sentences choosing the most suitable variant.

1. People prefer to fancy AI _____.

- a) as an abstract notion;
- b) as a human being;
- c) as an extraterrestrial creature.

2. AI tutoring systems _____.

- a) possess good skills of language fluency and knowledge of semantics;
- b) will acquire good fluency and understanding of meaning in the foreseeable future;
- c) are unable to display fluency and understanding of meaning.

3. Application of AI in the development of vaccines _____.

- a) expanded the range of scientists' enquiry;
- b) reduced the search area of experts;
- c) hasn't been considered yet.

4. AI began to be used _____.
 a) in writing personal letters instead of humans;
 b) on TV to host entertainment programs;
 c) in creating software.
5. The creation of sophisticated software by AI is _____.
 a) out of the question;
 b) too impractical;
 c) inevitable.

IV. Read passage 1 and answer the following questions:

1. What establishment made it possible to mix various musical works with the help of AI?
2. What is transferred to AI to create musical compositions?

V. Read passage 2 and describe the distinctive features of AI-generated embodiment.

VI. In passage 3 find the words or word combinations with a similar meaning to the following ones:

significant; fluency; to monitor; to stop; on condition; creator; to concede; comprehension; to unite.

VII. In passage 4 find the information about how AI concerns our life.

VIII. Translate passage 1 into Russian.

IX. Make an outline of the text.

X. Speak on:

1. The tools applied to create music co-written by AI and opportunities such techniques can provide.
2. The features and skills of future AI-generated avatars.
3. The spheres of AI application in people's life.

GRAMMAR FOCUS 2

4.1.5. Признаки распознавания определительных и обстоятельственных причастных оборотов с причастием II

the x hed + зависимые слова ↓ после существительного	ОПРЕДЕЛИТЕЛЬНЫЙ причастный оборот	делаемый, сделанный (-нный, -емый, -имый, -тый, -шийся, -вишийся), придаточным предложением
---	---	--

The indirectly heated cathode consists of cylinder *heated by filament*.

Катод с косвенным нагревом состоит из металлического цилиндра, *нагреваемого нитью накала*.

(When) xed ... ↓ в начале предложения перед подлежащим	ОБСТОЯТЕЛЬСТВЕННЫЙ причастный оборот	а) придаточным обстоятельством предложением: <i>когда сделали;</i> б) при + существительное, образованное от причастия: <i>при</i> <i>применении</i>
... (when) xed. ↓ в конце предложения;		
может вводиться союзами <i>when</i> «когда», <i>if</i> «если», <i>as</i> «как», <i>though</i> «хотя», <i>unless</i> «если ... не», <i>until</i> «пока ... не», <i>once</i> «раз уж», «как только» и др.		

When processed properly the substance receives the required properties. *При обработке соответствующим образом* вещество получает необходимые свойства.

Certain materials emit electrons *when heated*. *При нагревании* некоторые материалы испускают электроны.

I. Find the attributive and adverbial participial constructions with Participle II. Give their features and Russian equivalents.

1. The conference attended by scientists from different countries discussed new trends and methods in this field of research. 2. This guide, written especially for students of English as a foreign language, demonstrates the basic sentence patterns of contemporary English. 3. When heated, a body usually expands. 4. Once started, the process is difficult to stop. 5. An electronic computer forms an impressive complex device when viewed as a whole. 6. A body at rest remains at rest unless acted upon by an external force. 7. Written in pencil the article was difficult to read. 8. The devices produced by our plant are of improved quality.

II. Give the Russian equivalents of the following sentences. Pay attention to the translation of the participial constructions with Participle II.

1. The experiment made in our laboratory was a failure. 2. The information obtained by researchers is of great importance. 3. Once said a word cannot be unsaid. 4. Most of the liquid ethers decompose slowly if kept at room temperature. 5. Though generally criticized, this formula does describe the essential characteristics of the process. 6. Some heat-resistant types of glasses can be heated until they are red and they do not break, if then placed into ice water. 7. One of the rights enjoyed by University scientists is that of combining research with teaching. 8. When adequately heated the semiconductor doesn't work well.

4.1.6. Особенности перевода определительных оборотов с причастием II

<p>the x + xed +(prp)</p> <p>↓</p> <p>после существительного</p>	<p>ОПРЕДЕЛИТЕЛЬНЫЙ причастный оборот¹</p>	<p><i>Определительным придаточным предложением, начинающимся с соответствующего предлога ..., о которой</i> говорят</p>
--	---	---

¹Английские причастные обороты, образованные от глаголов, соответствующие русские эквиваленты которых принимают предложные дополнения.

This is the book *so much spoken about*. Вот книга, *о которой так много говорят*.

Запомните значения следующих глаголов:

<p>a) to agree upon/on smth. to arrive at smth.</p> <p>to depend on/upon smb., smth. to insist on/upon smth. to look at smb., smth. to look after smb., smth.</p> <p>to refer to smb., smth.</p> <p>to send for smb., smth. to speak, talk about/of smb., smth.</p> <p>b) to attack smth.</p> <p>to follow smb., smth.</p> <p>to join smb., smth.</p> <p>to influence smb., smth.</p>	<p>договориться, условиться о чем-либо приходить к чему-либо (заклучению, решению)</p> <p>зависеть от кого-либо, чего-либо настаивать на чем-либо</p> <p>смотреть на кого-либо, что-либо наблюдать за кем-либо, чем-либо; заботиться о ком-либо, чем-либо</p> <p>ссылаться на кого-либо, что-либо; упоминать о чем-либо</p> <p>посылать за кем-либо, чем-либо говорить о ком-либо, чем-либо</p> <p>энергично браться, приниматься за что-либо (работу, исследование)</p> <p>следовать, следить за кем-либо, чем-либо; следовать чему-либо</p> <p>присоединяться к (группе); вступать в (организацию)</p> <p>влиять, оказывать воздействие на кого-либо, что-либо</p>
---	--

III. Give the Russian equivalents of the following sentences. Pay attention to the translation of attributive constructions with passive participle.

1. The report followed by a lively discussion was rather cognitive. 2. The terms agreed upon were favorable. 3. The paper often referred to by many scientists was published two times. 4. The figures referred to in the report appeared last year. 5. The terms insisted upon could not be accepted. 6. The experiment watched with interest attracted attention of many researchers. 7. The new invention much spoken about was a real breakthrough. 8. The data looked at with great attention were unique. 9. The lecture followed by experiments took place last week. 10. The laboratory of

microelectronics joined by Professor Brown was established ten years ago. 11. The properties of the material influenced by electromagnetic radiation were taken into consideration.

4.1.7. Признаки распознавания независимого причастного оборота

The x + xing¹, the x ... ↓ в начале предложения	НЕЗАВИСИМЫЙ причастный оборот	Придаточным предложением Когда (так как, поскольку) ... делает, делал, будет делать
---	---	--

The experiment being carried out,
I will show the results to you.

Когда эксперимент будет проведен,
я покажу вам результаты.

..., (with) the x xing¹ ↓ в конце предложения	НЕЗАВИСИМЫЙ причастный оборот	Отдельным предложением и (а, но, причем) ... делает, делал, будет делать
---	---	---

¹Употребляются формы причастий *having xed, being xed, xed, having been xed.*

We defined the volume, *all the measurements having been done with respect to the instruction.*

Мы определили объем, *причем все измерения были выполнены в соответствии с инструкцией.*

IV. Define the absolute participial constructions and name their features. Give the Russian equivalents of the following sentences.

1. The temperature of a conductor being raised, the motion of the electrons in the conductor increases. 2. The resistance being very large, the current in the circuit was small. 3. Transistors are very sensitive to light, some of them reacting even to star-light. 4. The first man-made satellite having been set up, it became possible to investigate various types of radiation. 5. A new radio-set having been shown to them, they began to examine its details. 6. Numerous experiments having been carried out at the orbital stations, it became possible to develop new methods of industrial production of new materials. 7. Many substances are semi-conductors, germanium and silicon being the most important of them. 8. Part of energy being changed into heat, not all the chemical energy of the battery is transformed into electrical energy. 9. Some scientists do not distinguish between pure and applied mathematics, the distinction being, in fact, of recent origin. 10. They took all the measurements during the actual operation of the machine, this being the usual practice in those days.

V. Find participial constructions and give the Russian equivalents of the following sentences.

1. Some new devices having been obtained, the researchers could make more complex experiments. 2. Having made a mistake the designer couldn't continue his work. 3. The project abandoned, the leadership in this field passed to another institute. 4. Originally a mathematician, he became engaged first in theoretical physics and then in space research, all these fields being closely interconnected. 5. The problems of nanotechnologies attacked at the laboratory are of utmost interest. 6. The results

obtained by the researchers provided the same solution to the problem. 7. With research involving more and more people, the profession of a scientist has become one of the most popular nowadays. 8. He will achieve success working hard. 9. There are two diagrams in this figure, one of them showing the relation between volume and temperature. 10. Having developed a new type of robot he felt very excited. 11. An electron leaving the surface, the metal becomes positively charged.

VIDEO

«ARTIFICIAL INTELLIGENCE IN 5 MINUTES. WHAT IS ARTIFICIAL INTELLIGENCE? /AI EXPLAINED/ SIMPLILEARN», 5:28

(https://www.youtube.com/watch?v=ad79nYk2keg&ab_channel=Simplilearn)

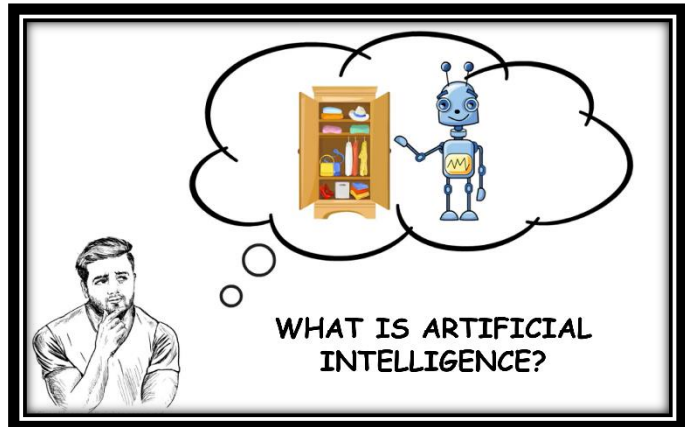

I. Before watching the video study the words which will help you understand the speaker.

core	essence
to generalize	to make or become more widely or generally applicable
reasoning	deduction
self-aware	self-conscious
unpredictable	not able to be predicted; not to be foreseen or foretold
subset	(<i>Math.</i>): a set of which all the elements are contained in another set
deep learning	a type of machine learning based on artificial neural networks in which multiple layers of processing are used to extract progressively higher level features from data
generalized learning	the ability to be able to transfer skills and knowledge learned to other settings, people and activities
machine learning	the concept that a computer program can learn and adapt to new data without human intervention
reasoning ability	the ability of the mind to think and understand things in a logical way

II. In pairs, discuss the following questions.

1. How can AI help people in everyday life?
2. What types of AI do you know?
3. What abilities does AI possess?
4. When will we have robots as smart as humans?

III. Watch the video and check if you were right.

IV. Watch the video again and define the following statements as true (T) or false (F). Correct the false ones.

1. In AI mathematical algorithms are used to perform different functions.
2. Generalized learning is the ability to respond properly to the known situation.
3. The key abilities AI transfers to the machines are to adapt, reason and provide solutions.
4. Weak AI concentrates on two tasks only.
5. Machine learning is a technique to realize AI.
6. Alexa can be considered strong AI as it can answer any questions and is able to express emotions.

V. Complete the sentences with the right option.

1. Strong AI of the future will be able to respond _____.
a) as was expected b) according to c) unpredictably d) in compliance with humans' orders strict instructions
2. Deep learning can be characterized as _____ of machine learning.
a) a script b) a subset c) an algorithm d) a function
3. In the future, as specialists forecast, human intellect and body will be enhanced by _____.
a) virtual reality b) computer graphics c) implants d) simulated 3D environment
4. Strong AI can be presented _____.
a) in fiction b) in real life c) in some branches of d) in electric medicine automobiles

VI. Explain what makes machine learning, deep learning and generalized learning different.

VII. Explain the notion of «the point of singularity» mentioned by Ray Kurzweil, a well-known futurist.

VIII. Say what Elon Mask forecasts about future robots.

IX. Compare predictions made by Elon Mask and Ray Kurzweil. Which of them do you find highly probable? Would you like to have implants in your body to become partly a cyborg? Why/Why not?

X. Speak about weak and strong AI. Do the quiz at the end of the video and comment on your answer.

XI. Could you predict where modern robots can't substitute humans. Justify your opinion.

XII. Express your point of view on the general tendencies of AI development.

I. Scan the text and define its main problems.**WHAT ARE NEURAL NETWORKS?**

1. The key to machine learning success is neural networks. These mathematical models are able to tweak internal parameters to change what they output. A neural network is fed datasets that teach it what it should spit out when presented with certain data during training. In concrete terms, the network might be fed greyscale images of the numbers between zero

and 9, alongside a string of binary digits – zeroes and ones – that indicate which number is shown in each greyscale image. The network would then be trained, adjusting its internal parameters until it classifies the number shown in each image with a high degree of accuracy. This trained neural network could then be used to classify other greyscale images of numbers between zero and 9. Such a network was used in a seminal paper showing the application of neural networks published by Yann LeCun in 1989 and has been used by the US Postal Service to recognise handwritten zip codes.

2. The structure and functioning of neural networks are very loosely based on the connections between neurons in the brain. Neural networks are made up of interconnected layers of algorithms that feed data into each other. They can be trained to carry out specific tasks by modifying the importance attributed to data as it passes between these layers. During the training of these neural networks, the weights attached to data as it passes between layers will continue to be varied until the output from the neural network is very close to what is desired. At that point, the network will have «learned» how to carry out a particular task. The desired output could be anything from correctly labelling fruit in an image to predicting when an elevator might fail based on its sensor data.

3. A subset of machine learning is deep learning, where neural networks are expanded into sprawling networks with a large number of sizeable layers that are trained using massive amounts of data. These deep neural networks have fueled the current leap forward in the ability of computers to carry out tasks like speech recognition and computer vision.

4. There are various types of neural networks with different strengths and weaknesses. Recurrent Neural Networks (RNN) are a type of neural net particularly well suited to Natural Language Processing (NLP) – understanding the meaning of the text – and speech recognition, while convolutional neural networks have their roots in

image recognition and have uses as diverse as recommender systems and NLP. The design of neural networks is also evolving, with researchers refining a more effective form of deep neural network called long short-term memory or LSTM – a type of RNN architecture used for tasks such as NLP and for stock market predictions – allowing it to operate fast enough to be used in on-demand systems like Google Translate.

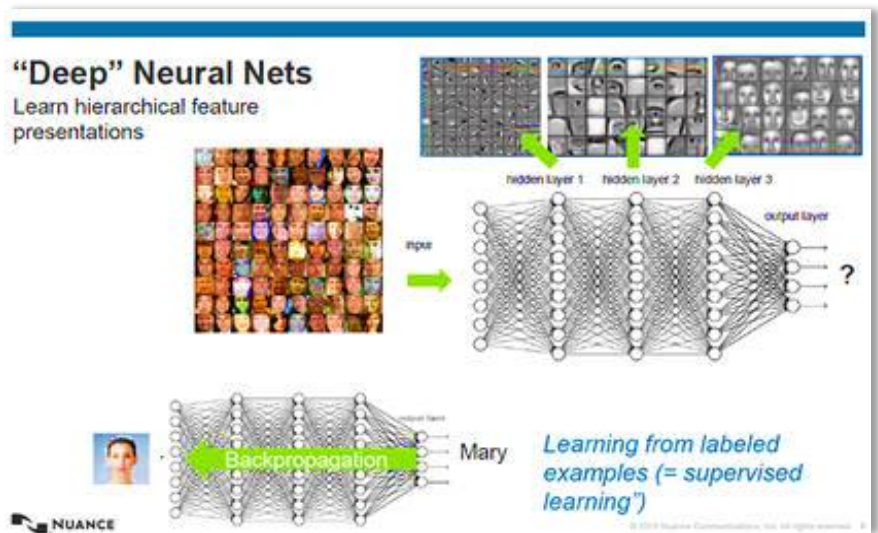

The structure and training of deep neural networks.

(<https://www.zdnet.com/article/what-is-ai-heres-everything-you-need-to-know-about-artificial-intelligence>)

II. Define which of the following information is mentioned in the text.

1. The fundamental components of machine learning.
2. Different kinds of neural networks.
3. The use of clusters of graphics processing units (GPUs) for parallel processing in machine learning.
4. Various learning styles in machine learning algorithms.
5. The training of neural networks to perform various tasks.
6. The challenges for machine learning practitioners.

III. Find the passage containing the information about the constituent elements of neural networks and explain how they are taught to fulfil particular tasks.

IV. Name and describe different kinds of neural networks mentioned in the text. Say which type is especially useful for text comprehension.

V. Find the passage characterizing deep neural networks and say what they are intended for.

VI. Express your point of view on neural networks. Give the main points of the text in 5-6 sentences.

VII. Have you ever used Google Translate? Can you name other multilingual neural machine translation services? What do you think about the quality of machine translation? In what situations can they be of great help? Do you think these services can replace human translators? Why/Why not?

4.2. Сравнение функций причастия I и герундия

Функция	Participle I	Gerund
1. Подлежащее	–	<i>Testing</i> a new device is a difficult task.
2. Дополнение: а) прямое б) предложное	–	а) He likes <i>testing</i> new devices. б) He thought of <i>testing</i> this device later.
3. Часть составного именного сказуемого	–	His greatest pleasure <i>is testing</i> new devices.
4. Часть составного глагольного сказуемого	–	He <i>began</i> ¹ <i>testing</i> the device.
5. Часть простого глагольного сказуемого	The engineer <i>is testing</i> a new device now.	–
6. Определение	The man <i>testing</i> a new device is our engineer.	The method of <i>testing</i> new devices is quite good.
7. Обстоятельство	<i>While testing</i> a new device, the engineer used a new method.	<i>Upon testing</i> a new device the engineer put down the data.

¹После глаголов, выражающих начало, продолжительность или конец действия: to continue, to cease, to start, etc.

Герундий может иметь перед собой:

- предлог, e.g.: *with, by, etc.*
- притяжательное местоимение *my (our, your, his, her, its, their) xing*;
- существительное в притяжательном падеже *Tom's xing*.

I. Read the sentences and decide whether the words in bold are the Gerund or Participle I.

1. **Freezing** an Android phone can help reveal its confidential content. 2. The advance could speed the development of smarter artificial skin capable of «**feeling**» activity on the surface. 3. This gives a way to gain performance while **shrinking** the device. 4. The researchers discovered that quickly **connecting and disconnecting** the battery of a frozen phone forced the handset into a vulnerable mode. 5. A router is a special computer **directing** messages when several networks are linked. 6. **Using** vertical zinc oxide nanowires, the researchers built arrays consisting of about 8000 transistors. 7. They include **finding** more efficient ways to sort through nanotubes which are made in a wide variety of sizes and types. 8. In the early 1980s viruses depended on humans to do the hard work of **spreading** the virus to other computers. 9. Virtual assistants **answering** questions, **providing** recommendations and **helping** organize daily routines have become ubiquitous.

II. Give the Russian equivalents of the following sentences.

1. Using this technique gives you more flexibility. 2. Researchers are also using machine learning to build robots that can interact in social settings. 3. Some harmful programs can create a backdoor allowing a remote user to access the victim's computer system. 4. Zach helped develop «A Slower Speed of Light», a videogame which explains the theory of relativity by enabling gamers to experience it. 5. Many countries have not only started using computer games in the classroom, but are also encouraging students to build their own games, even at a very young age. 6. New ways of interacting with computers have proliferated in recent years with technologies like touch screens, motion-sensing and eye-tracking. 7. AI technology is improving enterprise performance and productivity by automating processes or tasks that once required human power. 8. AI systems can help recognize and fight cyber attacks and other threats based on the continuous input of data, recognizing patterns and backtracking the attacks.

4.3. Герундиальные обороты

Герундий с относящимися к нему словами образует герундиальные обороты.

4.3.1. Признаки распознавания независимого герундиального оборота

<p>(of) the x's (x) xing + зависимые слова (of) my xing + зависимые слова ↓ - оборот стоит после предлога; - герундий стоит после существительного в притяжательном или общем падеже, притяжательного местоимения.</p>	<p>НЕЗАВИСИМЫЙ герундиальный оборот</p>	<p>- <i>придаточным предложением с союзами что; то, что; о том, чтобы; в том, что;</i> - <i>существительным.</i></p>
--	--	---

We all know of *their designing* a new type of semiconductor device.

Мы все знаем, *что они проектируют* новый тип полупроводникового устройства.

Prof. Smith's studying the properties of fiber attracted our attention.

То, что профессор Смит изучает свойства волокна, привлекло наше внимание.

Изучение профессором Смитом свойств волокна привлекло наше внимание.

4.3.2. Признаки распознавания зависимого герундиального оборота

<p>(by) xing + зависимые слова</p> <p style="text-align: center;">↓</p> <p>герундий стоит после предлога</p>	<p>ЗАВИСИМЫЙ герундиальный оборот</p>	<p>- <i>придаточным предложением с союзом то, что (о том, чтобы; в том, что) в том падеже, который определяется предлогом;</i></p> <p>- <i>существительным.</i></p>
---	--	---

This device differs from that one **by** Это устройство отличается от того устройства тем, **что оно имеет более высокую производительность.**

Это устройство отличается от того устройства **наличием более высокой производительности.**

III. Find the sentences with the Gerundial constructions and define their features. Give the Russian equivalents of these sentences.

1. In spite of not having the necessary expertise, the scientist made his great discovery. 2. These substances are alike in having high melting points. 3. Adding more turns makes the magnetic field stronger. 4. It is worthwhile considering more carefully the implication of the research results. 5. The scientist investigated the possibility of these rays being charged particles. 6. The analyst's efficiency may be attributed to his having acquired, by constant training, the necessary technique. 7. To calculate the motion of an electron, we investigate the accompanying wave motion instead of using classical point mechanics. 8. The physicist's being awarded the Nobel Prize soon became widely known. 9. Being appointed the head of the Department, Dr. Black started his work on atomic collisions. 10. The actual number of electrons depends upon the atom being considered.

SUMMARY WRITING

I. Read the text and write a short summary of it.

AI PROGRAMMER MAY BE REUSING CODE WITHOUT ASKING

By Matthew Sparkes

A MICROSOFT-owned tool powered by artificial intelligence is designed to make life easier for programmers, but some developers say it may be repurposing some of the billions of lines of code it was trained on without permission.

The tool, called CoPilot, was released by GitHub, a Microsoft subsidiary that is used by millions of people to share source code and organise software projects. CoPilot uses powerful neural network tools developed by Open AI to solve programming problems by scouring vast

numbers of examples of existing solutions, both from GitHub and elsewhere, and learning how to create similar solutions. It then suggests code based on a human programmer's work in progress or English descriptions of the functionality needed.

But sometimes CoPilot may directly plagiarise its training data, says Armin Ronacher at software company Sentry. He has found that it is possible to prompt CoPilot to suggest copyrighted code from the 1999 computer game Quake III Arena, complete with comments from the original programmer. «You can definitely make it recite code that is almost entirely in the training set where there's no originality happening», says Ronacher, although he says it should be possible to adjust CoPilot so that it warns the user if code being output is close to original work.

A more difficult problem to solve is that many of the software projects that CoPilot has been trained on are released under free software licences such as the General Public License, or GPL, that only allow derivative works if they are also freely released. This doesn't stop them being used commercially. «Free» in this context means that people are free to modify the code, but it does mean that people using CoPilot would in theory also be required to release any source code they create for other people to use. However, the CoPilot website says that copyright for the code it generates belongs to the programmer using it.

Some developers have already taken action to protect their work. Adrian Bowyer at RepRap, an open source 3D printer project, says CoPilot is a great idea but anything it creates must itself be open source. He has altered the wording of the



licence under which he releases software: «If any part of RepRap covered by the GPL is used to train any AI, then all the products of that AI must be released under the GPL as free software».

The CoPilot website says that about 0.1 per cent of CoPilot suggestions may contain «some snippets» of verbatim code from the training set.

Neil Brown at UK law firm says that GitHub has made a «bald assertion» that it can analyse code in the way CoPilot does under the fair use copyright infringement defence in the US, but the position in the UK is less clear.

Yin Harn Lee at the University of Bristol, UK, agrees that CoPilot could be allowed under US copyright law, which is less prescriptive, but says it is a grey area in the UK that needs to be tested in court. The US fair use is a broader, less defined and more unpredictable defence. UK copyright law tends to offer a much clearer definition of what is and isn't acceptable.

«I'm very keen for it to be tested, because I want to know», says Harn Lee. Microsoft and Open AI didn't respond to requests for comment, while GitHub declined to comment.

(New Scientist, 17 July 2021, p. 13)
(<https://www.newscientist.com/article/2283136-githubs-programming-ai-may-be-reusing-code-without-permission>)

FOLLOW UP

I. Work in groups and discuss the following questions:

1. What are the uses for AI?
2. What kind of ethical implications, challenges and risks in education can be considered?
3. What AI technologies are you most looking forward to in the coming years?

II. Work in pairs. In the table below you will find the list of impacts of AI on society that can be referred either to good or bad, but some of them by error have been referred to the wrong group. Correct the mistakes. Add some more types of AI impacts on society to the table.

<i>Good</i>	<i>Bad</i>
<ul style="list-style-type: none">- new responsibilities with uniquely human abilities;- far-reaching economic, legal, political and regulatory implications;- evolving of workforce;- the loss of control;- unforeseen consequences;- crosses over ethical or legal boundaries.	<ul style="list-style-type: none">- our privacy getting compromised;- devolving into social oppression;- creativity and empathy;- healthcare;- autonomous transportation;- facial recognition technology.

III. Work in groups. Present your viewpoint on positive/negative impacts of AI on society to the groupmates. Give arguments.

IV. Role play the following situation in pairs.

Student A

Spammer Sally: You are a fan of modern quickly developing IT technologies. You are sure that evolving AI is a firm guarantee of success of our civilization and our future welfare. Prove your point of view.

Student B

Garry: You are Sally's best friend. You are worried about unforeseen negative consequences of introducing AI into our life. You consider that scientists and humanity as a whole should analyze correctness of the chosen path of our civilization. Try to convince Sally that we may be trapped and lose control of everything and face very complicated problems.

V. Read and comment on the following quotes about AI. Which of them do you support? Justify your point of view.



«I fear that AI may replace humans altogether. If people design computer viruses, someone will design AI that improves and replicates itself. This will be a new form of life that outperforms humans». *Stephen Hawking*



«AI is like nuclear energy – «both promising and dangerous». The power of artificial intelligence is «so incredible, it will change society in some very deep ways». *Bill Gates*



«Artificial intelligence is extending what we can do with our abilities. In this way, it's letting us become more human». *Yann LeCun*



«Before we work on artificial intelligence why don't we do something about natural stupidity?». *Steve Polyak*



«The pace of progress in artificial intelligence (I'm not referring to narrow AI) is incredibly fast. Unless you have direct exposure to groups like Deep mind, you have no idea how fast it is growing at a pace close to exponential. The risk of something seriously dangerous happening is in the five-year time frame. 10 years at most». *Elon Musk*

VI. Do you know about recent breakthroughs in AI development? Search for more facts on the Internet and share them with your groupmates.

The following link might be helpful:



<https://www.zdnet.com/article/what-is-ai-heres-everything-you-need-to-know-about-artificial-intelligence>

PART II

AI IN EVERYDAY LIFE



«I think a lot of people don't understand how deep AI already is in so many things».

Marc Benioff

STARTING UP

I. Discuss these questions in groups.

1. Do you believe robots will ever think like humans?

2. Will Artificial Intelligence help or

hurt people in their everyday life? Why?

3. What activities are computers better at than humans are? Which are humans better than computers?

4. What are the dangers of Artificial Intelligence?

5. What three adjectives best describe Artificial Intelligence?

6. Is there a difference between Artificial Intelligence and robots?

7. How could the Artificial Intelligence technology be used in the future?

8. Is your future job «safe» from AI risks or robots?

II. A. Read the information about the laws of robotics discovered by Isaac Asimov and comment on them.

Isaac Asimov, (born January 2, 1920, Russia – died April 6, 1992, New York, U.S.), was an American author and biochemist, a highly successful and prolific writer of science fiction and of science books. He is extremely famous for his so-called «Three Laws of Robotics»:



- «A robot may not injure a human being or, through inaction, allow a human being to come to harm».
- «A robot must obey orders given it by human beings, except where such orders would conflict with the First Law».
- «A robot must protect its own existence as long as such protection does not conflict with the First or Second Law».

(<https://www.scientificamerican.com/article/asimovs-laws-wont-stop-robots-from-harming-humans-so-weve-developed-a-better-solution/>)

B. Can these laws be applied to the increasing spread of Artificial Intelligence? Do you think these three laws are enough to protect people from robots? Do you have any other ideas?

III. In pairs, look at the picture and discuss the following question: In what areas of life has AI reached its development?

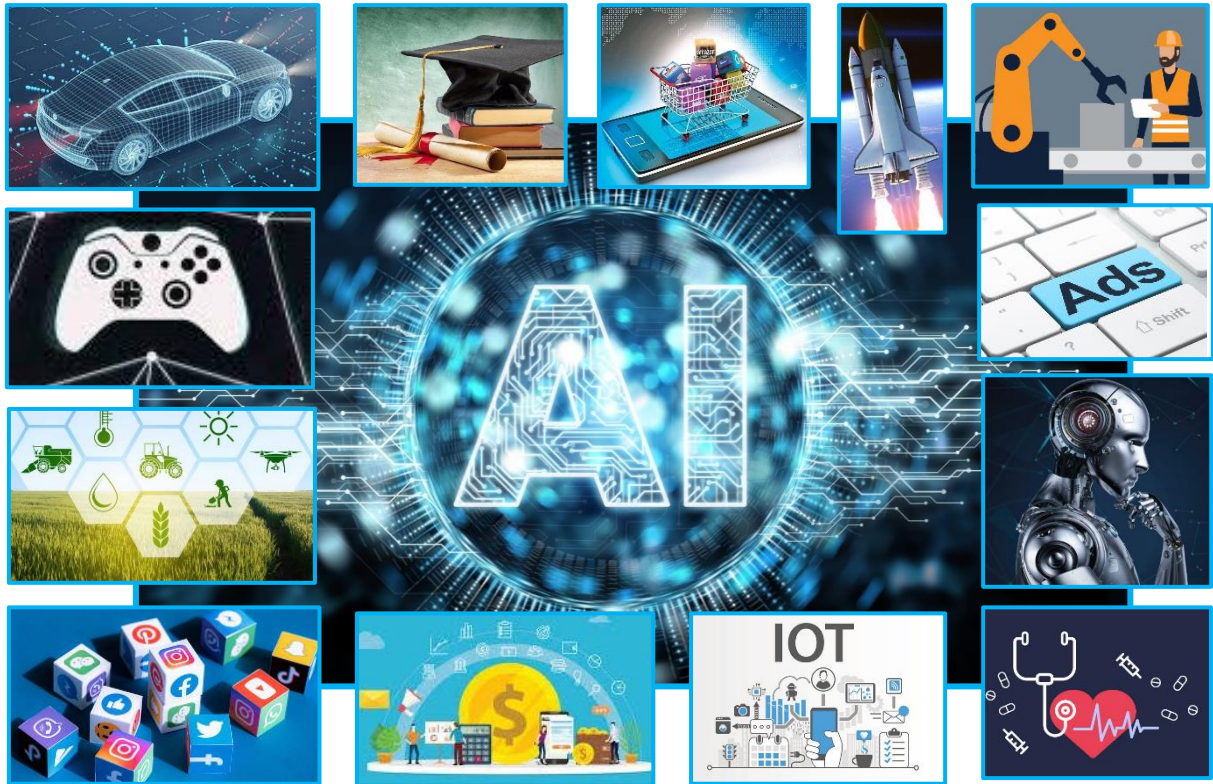

<https://learningapps.org/display?v=p4pk478tc21>

IV. Do the quiz and check how smart you are in AI.

10 INSIGHTFUL FACTS YOU DIDN'T KNOW ABOUT ARTIFICIAL INTELLIGENCE

1. AI pets _____.
A. exist **B.** will never appear **C.** died **D.** are under development
2. Most AI bots are _____.
A. male **B.** female **C.** more male than female **D.** more female than male
3. AI recognizes emotions.
A. It is the matter of future **B.** No **C.** Yes **D.** It is impossible
4. AI can _____.
A. repair itself **B.** be repaired only by AI programmers **C.** not be repaired **D.** be repaired in special conditions

5. AI can replace _____.
A. computers **B.** smartphones **C.** robots **D.** human workforce
6. AI will become smarter than _____.
A. robots **B.** satellites and drones **C.** humans **D.** IT specialists
7. Humans can develop a romantic relationship with AI.
A. Yes. **B.** No, it will never happen. **C.** It is just a suggestion of scientists. **D.** It is said in some science fiction films.
8. AI has _____.
A. encrypted algorithms **B.** nationalities and passports **C.** an immense sense of responsibility **D.** excellent traits of character
9. AI can _____.
A. jump **B.** swim **C.** write **D.** smile
10. AI will recognize people by _____.
A. gestures **B.** breathing **C.** signing **D.** voice

For detailed information about the facts mentioned above check:



<https://www.analyticsinsight.net/10-insightful-facts-you-didnt-know-about-artificial-intelligence/>

READING 1

I. Look through the text and entitle it.

II. The text is divided into logical parts. Scan the text and match the headings to the gaps at the start of each paragraph. There are two extra headings that you don't need to use.

- A.** Everyday Commuting.
- B.** Intelligent Home Tools.
- C.** Biometric Identification.
- D.** Information Retrieval.
- E.** Robots Application.
- F.** Online Vender's Tips.
- G.** Internet Community.
- H.** AI in Entertainment Industry.
- I.** AI Aider.
- J.** Distance Learning.

III. Read the text and write out key words and phrases revealing the content of the text.

IV. In each part of the text find the topical sentence.

When you hear news about artificial intelligence (AI), it might be easy to assume it has nothing to do with you. You might imagine that artificial intelligence is only

something the big tech giants are focused on, and that AI doesn't impact your everyday life. In reality, artificial intelligence is encountered by most people from morning until night. Here are some of the best examples of how AI is already used in our everyday lives.

1

One of the first things many people do each morning is to reach for their smartphones. And, when your device gets unlocked using biometrics such as with face ID, it's using artificial intelligence to enable that functionality. Apple's Face ID can see in 3D. It lights up your face and places 30,000 invisible infrared dots on it and captures an image. It then uses machine learning algorithms to compare the scan of your face with what it has stored about your face to determine if the person trying to unlock the phone is you or not. Apple states the chance of fooling Face ID is one in a million.

2

After unlocking their phones, what's next? Many people check out their social media accounts, including Facebook (Meta), Twitter, Instagram, and more, to get updated on what happened overnight. Not only is artificial intelligence working behind the scenes to personalize what you see on your feeds (because it's learned what types of posts most resonate with you based on past history), it's figuring out friend suggestions, identifying and filtering out fake news and machine learning is working to prevent cyberbullying.

3

Most of us can't go a day without searching Google for an answer or a product we can't live without. Search engines couldn't scan the entire internet and deliver what you want without the assistance of artificial intelligence. Those ads that seem to follow you around? Yep, those are enabled by AI, are based on your search history and are personalized to you with the goal of getting items in front of you that the algorithms believe you will value.

4

From getting directions to your lunch spot to inquiring about the weather for your weekend getaway, digital voice assistants are quickly becoming our can't-live-without co-pilots through life. These tools from Siri and Alexa to Google Home and Cortana, use natural language processing and generators driven by AI to return answers to you.

5

Our homes are increasingly becoming «smart». Many of us now have «smart» thermostats such as the Nest that learn about our heating/cooling preferences and daily habits to adjust the temperature to our liking in time for our return home. There are smart refrigerators that create lists for what you need based on what's no longer in your fridge, as well as offer drinks recommendations that would go with your dinner. Of course, smart appliances will continue to be more common.

6

The travel aids enabled by artificial intelligence include more than maps. Google maps and other travel apps use AI to monitor traffic to give you real-time traffic and weather conditions as well as suggest ways to avoid gridlock. The car you drive to work might have driver-assist technology, and in places such as Mountain View, California, you can request a self-driving car through Google's sister company Waymo to drive you to and from work.

7

Speaking of shopping, America's largest online retailer Amazon is another way many people are exposed to artificial intelligence regularly. The retailer's AI algorithms learned what you like and what other people who are like you purchased to deliver to your Amazon feed recommendations for what you might like in your carts. Amazon is so confident in its predictive analytics and algorithms that it will ship products towards you even before you «click to buy» with its anticipatory shipping algorithm.

8

At the end of the day, when it's time to kick back and relax, many of us turn to streaming services such as Netflix. The company's recommendation engine is powered by artificial intelligence and uses your past viewing history to deliver suggestions for what you might want to watch (including genres, actors, time periods, and more). Its tool gets as specific as what time of day you were watching and what you traditionally like during that timeframe. In fact, 80% of what we're watching is driven by Netflix's recommendations.

So, it will be hard to imagine any of our daily routines without the help of AI.

(<https://www.forbes.com/sites/bernardmarr/2019/12/16/the-10-best-examples-of-how-ai-is-already-used-in-our-everyday-life/?sh=26ddd5421171>)

V. Read the statements below and decide which of them correspond to the content of the text.

1. AI affects our daily life becoming an essential part of it.
2. AI helps users get trusted information without losing their personal data.
3. Users get used to AI applications so much that it is impossible for them to exist without their help.
4. AI provides people with up-to-the-minute information about the vehicle flow on the roads and atmospheric conditions of the region where a person travels.
5. The only sphere AI can't control is medicine. It is totally monitored by qualified specialists.
6. AI is cut out for preventing users from different forms of computer crimes.
7. Entertainment services are highly upgraded with AI technologies proposing users the content according to their interests and tastes.

VI. Look through the text and find the sentences which prove that:

1. Face ID is a reliable technology that ensures users' safety.

2. AI checks and monitors social networks giving feedback to their users.
3. AI controls information traffic on the Internet, helping people retrieve the information from search engines.
4. AI transformed our accommodation into an intelligent environment.
5. Today's virtual shopping is much more convenient with AI assistance.

VII. Express your attitude to the facts given in the text. Use the following phrases:

- The text is of interest to _____ because _____.
- I'd like to point out that _____.
- I consider it important/crucial/essential/useful/likely/to _____.
- It seems obvious that _____.
- It goes without saying that _____.
- I am of the opinion that _____.

VIII. Explain the role of artificial intelligence in the following areas of our everyday life:

- a) social media communication;
- b) information search;
- c) smart home appliances;
- d) commuting and travelling;
- e) e-commerce;
- f) pastime relaxation.

IX. Say whether AI brings more advantages or disadvantages to our life? Share your viewpoint with the groupmates.

X. Sum up the text using key words, word combinations and topical sentences.

XI. Say what new information about AI you have learnt from this text.

GRAMMAR FOCUS 1

4.4. The Infinitive Constructions

4.4.1. Признаки распознавания определительных инфинитивных оборотов

<p>1. ... to be xed</p> <p style="text-align: center;">↓</p> <p>после существительного</p> <p>2. the (first, second, third, etc.) to x</p>	<p>ОПРЕДЕЛИТЕЛЬНЫЙ инфинитивный оборот</p>	<p>Определительным придаточным предложением который будет, должен, может делаться ... первым (и т. д.) кто (с)делал, делает, будет делать</p>
--	---	---

The measurements *to be analyzed* should be accurate enough.

Измерения, *которые будут (должны, могут) анализироваться,* должны быть достаточно точными.

I. Define the attributive infinitive constructions. Give the Russian equivalents of the following parts of the sentences:

1) an important issue to be discussed was; 2) there is research to be held; 3) the project elements to be studied carefully are; 4) the engine to be repaired urgently was; 5) a new approach to be applied in the experiment found out; 6) the system bugs to be fixed were; 7) was the first to realize the difficulty of the situation; 8) was the last to use this application.

II. Give the Russian equivalents of the following sentences. Pay attention to the attributive infinitive constructions.

1. The plan of our work will be discussed at the meeting to be held on May 25.
 2. The metal to be poured into a mould for casting may contract or expand on solidifying.
 3. He was the first to apply the new method of work.
 4. Nearly all refrigerators to be used at home are based upon the principle that the rapid evaporation of a liquid or the expansion of a gas produces cooling.
 5. He described the device to be used in all modern systems.
 6. The apparatus to be assembled is very complicated.
 7. A. Lodygin was the first to invent the electric lamp.

4.4.2. Признаки распознавания обстоятельственных инфинитивных оборотов

1. To x ... 2. to x перед подлежащим или в конце предложения 3. in order to x 4. so (such) as to x 5. enough to x, too x to x, sufficient to x, sufficiently x to x	ОБСТОЯТЕЛЬСТВЕННЫЙ инфинитивный оборот	1. чтобы делать
		2. чтобы делать
		3. чтобы делать
		4. так чтобы делать, с тем чтобы делать
		5. достаточный (слишком, достаточный, достаточно), чтобы делать

The research results have to be presented *so as to be easily understood by everybody*.

Результаты исследования должны быть представлены так, *чтобы все могли легко их понять*.

The issue is *too complicated to make fast conclusions*.

Вопрос слишком сложный, *чтобы (можно было) делать скорые выводы*.

III. Define the adverbial infinitive constructions. Give the Russian equivalents of the following parts of the sentences:

1) came to discuss the research issues; 2) changes introduced so as to meet the requirements; 3) competent enough to carry out the experiment; 4) so as to apply a new method; 5) hired to create a new software solution; 6) research launched in order to attain expected results; 7) designed to optimize the process; 8) too complicated to be solved easily.

IV. Give the Russian equivalents of the following sentences. Pay attention to the adverbial infinitive constructions, give their features.

1. The issue was complicated enough to provoke the debates at the conference. 2. The question is too controversial to deal with it without thinking everything over. 3. One more meeting was organized so as to further discuss the research outcomes. 4. To explain the problem he drew diagrams all over the blackboard. 5. The software developer improved the application in order to meet the requirements. 6. The results of the scientific conference were fruitful enough to start a lot of new partnerships. 7. In order to solve these problems, scientists must make many experiments. 8. The temperature was sufficiently hot to conduct the experiment. 9. We will consider a very simple example in order to explain this phenomenon.

V. Define the meaning and the function of the multifunctional verb to be.

1. She was the first to discover this principle of work. 2. The robot to be used is very lightweight. 3. These measurements are to be used in the research. 4. Scientists were to make many experiments to prove this fact. 5. It is necessary to develop a special machine to explore different surfaces. 6. Information must be relevant, timely, accurate, concise and complete in order to be useful. 7. Virtually all countries have recognized that to be part of the world economy, they must be part of the world communications systems.

WORD FORMATION

I. Define which of the words below are a) verbs; b) nouns; c) adjectives. Give their Russian equivalents.

Detector; invention; simplify; enforcement; employ; practice; application; tether; combine; development; succeed; approve; deepen; medium; lengthen; accomplishment; purify; complaint; remake; high; threaten; afford; realize; available; imply; persuade; observe; existence; equipped; vulnerable; bandwidth; facilitate; deduct; outline; enlarge; implementation; remote; subsequent; execute; launch; linear; drawback; succession; input; distinguish; emergence; versatile; handheld; retrieve; enhance; width; processed.

II. Choose an appropriate word and complete the sentences.

a) application, misapplication, applicable

1. Software is categorized as _____ software or system software.
2. No single method, however, is ever going to be universally _____.
3. It is therefore an imperative to avoid the _____ of a good idea.

b) advance, advancement, advanced

1. This kind of _____ technology combines intelligent systems and digital image processing with mechanical and aerospace engineering technology.
2. In the last five years, the field of AI has made a great _____ in its standard subareas, including natural language processing (NLP) and decision-making operations.

3. Consumers can select an alternative operator in _____ to carry certain predefined types of calls.

c) interactive, interactivity, interaction

1. The site promises to be strong on _____, boasting online tours of museums and live theatre workshops.

2. When designing your site, think about whether it needs to be _____ or informational.

3. _____ designers focus on the way users interact with products and they use principles of good communication to create desired user experience.

III. Complete the word families in the table below.

<i>Verb</i>	<i>Noun</i>	<i>Adjective</i>
	operator	
create		
	originator	
implement		
		adjustable
process		
	computer	
		identifiable
	maintainability	
communicate		

IV. Choose an appropriate word and complete the sentences.

1. Gamers should take into consideration that in this computer game some elements are **destroyable/falling out**.

2. Researchers are to examine **curious/various** ways in which the work can be completed; one is not enough.

3. Computer programs are written in a «code» rather than in a **conventional/conditional** language.

4. These two methods turned out to be **incomparable/unable** in effectiveness.

5. Machines are not **reliant/ reliable** and sometimes break down so we should limit their usage in our everyday life.

6. Advanced drones are pilotless **programmable/programming** aircraft used for some special purpose.

7. A debugger is a **general-purpose/special** program used to test and debug other problems.

V. Complete the sentences with the correct form of the words given in capitals at the end of the sentences.

1. _____ have announced that a major breakthrough has been made.

RESEARCH

2. The scientist said that she had an announcement of international _____.

IMPORTANT

3. If there are aliens out there, do you think they are much more _____ advanced than we are?

4. Most scientific _____ use some form of the scientific method.

5. This information should be made more _____ to the public.

6. Students would like to see the new computer system in _____.

7. The _____ has caused great excitement amongst _____.

8. Machines multiply our labor and increase our _____ to do work.

9. Students need the skill to construct a logical _____.

**TECHNOLOGY
INVESTIGATE**

ACCESS

**ACTIVE
DISCOVER
SCIENCE
ABLE**

ARGUE

VI. Use the words given in capitals at the end of each line to form a word that fits in the gap in the same line.

«QUALCOMP» POWERTOP

«Qualcomp» have just brought out their 1. _____ new handheld computer, the Powertop. It's 2. _____ not to love it, with its smooth, shiny 3. _____ and its bright screen. It might not be the best 4. _____ to handheld computing because it is quite advanced, but you'll find an 5. _____ of all the features in the detailed manual.

The Powertop has been 6. _____ designed to fit a lot of computing power in your palm. The 7. _____ of a unique wireless Internet connection means there's a world of 8. _____ just waiting for you.

**REVOLUTION
POSSIBLE
APPEAR
INTRODUCE
EXPLAIN**

**SCIENCE
INVENT
DISCOVER**

(From *Destination B2* by M. Mann, S. Taylore-Knowles)

WORD STUDY

I. Match the words to the definitions.

- 1) interception, *noun*
- 2) surveillance, *noun*
- 3) retain, *verb*
- 4) recognition, *noun*
- 5) tether, *verb*
- 6) amass, *verb*
- 7) enforcement, *noun*
- 8) assessment, *noun*
- 9) disseminate, *verb*

- a) to continue to hold or contain smth.;
- b) gather together or accumulate (a large amount or number of material or things) over a period of time;
- c) an opinion or a judgment about smb./smth. that has been thought about very carefully;
- d) an act or instance of receiving electronic transmissions before they reach the intended recipient;
- e) to spread information, knowledge, etc. so that it reaches many people;
- f) the act of carefully watching a person suspected of a crime or a place where a crime may be committed;
- g) to tie (an animal or smth.) with a rope or chain so as to restrict its movement;

- h) identification of a thing or person from previous encounters or knowledge;
- i) the act of compelling observance of or compliance with a law, rule, or obligation.

II. Match the words/word combinations to the ones with a similar meaning:

- | | |
|---------------------|--------------------------|
| 1) unmanned vehicle | a) suggestion |
| 2) tracker | b) to arrange/to install |
| 3) proposal | c) pilotless |
| 4) to vary | d) stance |
| 5) to deploy | e) to pursue/to follow |
| 6) pose | f) navigator |
| 7) to chase | g) to differ |

III. Replace the words in bold with the ones from the box with a similar meaning:

a) complicated	b) height	c) repower	d) obtained
e) stucked	f) acted out	g) secretly follow	h) recognize

1. There was a sudden drop in the drone's **altitude**.
2. That «smart house» gadget can be **attached** to any vertical or near vertical surface.
3. Video cameras are being used in public places to **spy** on people.
4. A great part of the information for this research was **acquired** by looking up scientific journals and monographs and finding experiment results on the Internet sites.
5. Modern aircraft are **sophisticated** and often built from highly stressed, lightweight materials.
6. This operation has never been **performed** without special equipment.
7. It is possible to **recharge** the battery while the USB cable is connected to the unit.
8. This app would **identify** computer viruses, worms, trojans and other malicious software.

IV. Choose the most suitable word in bold in each sentence.

1. Some devices like infrared cameras allow for **persistent/resistant** surveillance.
2. In emails user can **detach/attach** lots of files to share with.
3. First of all, students must **identify/imply** the problem areas.
4. This metal should not be **subjected/rejected** to too high temperatures.
5. The engineer made a careful **advancement/assessment** of the situation.

READING 2

I. Read the text and give the definition of a drone.

DRONES OR UNMANNED AERIAL VEHICLES (UAVs)

1. Drones are unmanned aerial vehicles that can be equipped with high definition, live-feed video cameras, thermal infrared video cameras, heat sensors, and

radar – all of which allow for sophisticated and persistent surveillance. Drones can record video or still images in daylight or infrared. They can also be equipped with other capabilities, such as cell-phone interception technology, as well as backend software tools like license plate readers, face recognition, and GPS trackers. There have been proposals for law enforcement to attach lethal and non-lethal weapons to drones.

2. Drones vary in size, from tiny quadrotors to large fixed aircraft. They are harder to spot than airplane or helicopter surveillance and can sometimes stay in the sky for a longer duration. Some drones are tethered to the ground with a very thin wire so that they do not need to land to recharge their batteries. Drones are different than manned aircraft because they are generally smaller, less expensive, faster to deploy, and are able to fly at low altitudes and, in some cases, indoors. Some drones are controlled manually through hand-held devices. These usually have a video camera attached to them, not just for surveillance, but for the operator to view through the camera to control the drone. Some drones may also be autonomous in the sense that they can fly and perform certain functions without continuous operator engagement.



Some drones may also be autonomous in the sense that they can fly and perform certain functions without continuous operator engagement.

3. Civil agencies often use drones to survey land and monitor animal populations. Many academic institutions acquire drones for educational purposes. Private parties often use drones for recreation, research, and journalism. On some occasions, private individuals have used drones to spy on people through windows. Drones can be equipped with various types of surveillance equipment that can collect high definition video and still images day and night. Drones can be equipped with technology allowing them to intercept cell phone calls, determine GPS locations, and gather license plate information. Drones can be used to determine whether individuals are carrying guns. Synthetic-aperture radar can identify changes in the landscape, such as footprints and tire tracks. Some drones are even equipped with facial recognition.

4. Drones pose a multitude of privacy risks because they can amass large amounts of data on private citizens, including those engaging in constitutionally protected activity, even if they have not been accused of a crime. Some cities in the USA have passed municipal regulations restricting government use of drones, such as limits on video storage and retention of personally identifiable information. However, the concern that drones might be used for more generalized surveillance remains. This includes the possibility that video of bystanders collected incidentally to search and rescue operations, land surveying, or police chase operations may be subjected to face recognition or other forms of biometric analysis.

5. In late 2015, the US Department of Homeland Security released guidance for state and local agencies using drones. It suggested limits on how drones collect data, how that data is used, how long it is retained, and to whom and for what purposes it is disseminated. It even recommends ongoing assessment of privacy impacts, as well as

a redress program. But the guidance isn't legally binding, and did not address drones used by law enforcement for investigative purposes.

(<https://www.eff.org/ru/pages/dronesunmanned-aerial-vehicles>)

II. Define the following statements as true (T) or false (F). Correct the false ones. Find evidence in the text.

1. Drones are pilotless machines that are frequently used for purposeful observation.

2. Drones are quite pricy, difficult to detect and require continual manual control.

3. Due to their abilities and high potential, drones are capable of performing multiple tasks and functions in different fields.

4. UAVs are able to recognize people or objects because of their build-in ID capabilities.

5. There are some limitations that deal with personal information drones can collect.

6. Both regulations and ethical norms have already been introduced to use drones for civil purposes.

III. Complete the following sentences choosing the most suitable variant.

1. Drones can be equipped with _____.

a) built-in cameras, various detectors, locators, as well as navigation systems;

b) lethal and non-lethal weapons only;

c) petrol engine.

2. Drones _____.

a) are similar to manned aircraft;

b) differ in dimensions, specifications and performance;

c) constantly complete their operations under the operator's control.

3. Civil agencies and organizations use drones for _____.

a) surveillance;

b) gathering confidential information;

c) educational, research, animal and land protection purposes.

4. Several US cities introduced _____.

a) measures to ban the usage of drones;

b) rules imposing bounds on government use of UAVs;

c) rules how to register drones.

5. Guidance for state and local agencies using drones suggests limits on how drones _____.

a) should be stored;

b) can be eco-friendly charged;

c) how the data collected by drones is used and saved.

IV. Read passage 1 and answer the following questions:

1. What can drones be supplied with?

2. Are special conditions required for drones to record video?
3. What has been suggested attaching to UAVs?

V. Read passage 2 and explain what makes drones different from aircraft and helicopters.

VI. In passages 3 and 5 find the words or word combinations with a similar meaning to the following ones:

To keep an eye on; to gather; to examine; to define; to keep; investigation; officially; tracking tools; to grab hold of; identification; to recognize; to obtain; to bring to public attention; recommendations; aim; to distribute; estimation; companies; provided with.

VII. Translate passage 3 into Russian.

VIII. In passage 4 find the information about certain guidelines limiting the use of drones.

IX. Make an outline of the text.

X. Speak on:

1. Types and functionality of UAVs.
2. UAVs applications.
3. Drone regulations.

VIDEO

«WORLD'S FIRST URBAN AIRPORT FOR DRONES AND FLYING TAXIS TO START OPERATIONS BY NOVEMBER», 3:04

(https://www.youtube.com/watch?v=Im69_BbTjbs&ab_channel=WION)



I. Look at the picture. In pairs, discuss the following questions:



1. Can you guess what object is shown in this picture?
2. Is this picture taken from a science fiction film or from real life?
3. Where is it situated, in your opinion?
4. What is it created for?

II. Before watching the video study the words that will help you understand the speaker. Match the words to their definitions.

- | | |
|--------------------------|--|
| 1) urban | a) goods carried on a ship, aircraft, or motor vehicle; |
| 2) hub | b) designed for people to live in; |
| 3) operation | c) the effective center of an activity, region, or network; |
| 4) cargo | d) in the process of being planned or developed; |
| 5) to be in the pipeline | e) in, relating to, or characteristic of a town or city; |
| 6) aerial | f) a seating area in an airport for waiting passengers; |
| 7) residential | g) existing, happening, or operating in the air; |
| 8) lounge | h) to pay the check; |
| 9) challenge | i) the action of functioning or the fact of being active or in effect; |
| 10) to foot the bill | j) a call to prove or justify something. |

III. Now watch the video and check if you were right.

IV. Complete the sentences with the words from the box.

a) foot the bill	b) cargo	c) mobility	d) board
e) a hub	f) infrastructure	g) vertical	h) flying

1. The world's first urban airport is intended to act as _____ for future electric _____ takeoff and landings of _____ drones and _____ taxis.
2. This new form of urban aerial _____ will require its own dedicated supporting _____.
3. When will passengers be able to _____ a flying taxi? Those who can afford to _____ will have this chance very soon.

V. Watch the video again and define the following statements as true (T) or false (F). Correct the false ones.

1. The world's first urban airport for flying taxis has been put into operation in the UK this year.
2. Some big corporations have already used drones for transporting parcels and goods.
3. Flying taxis can use the existing infrastructure for carrying passengers.
4. There's a stiff competition between different companies all over the world to get certification in the nearest future.
5. The biggest problem about flying taxis is the urgent need for official regulations or «rules» to fly over inhabited areas.
6. With the development of technology short automated movement air corridors will be established.

VI. Express your opinion on the following quotes about flying taxis. Say which viewpoint do you most agree or disagree with. Give your arguments.



«When air taxis become widely commercialized, they will definitely ease the traffic burden on city roads. They will usher in a nimble form of intracity travel, transporting people on the shortest possible route between two locations». *Joe Praveen Vijayakumar*



«We could definitely make a flying car – but that’s not the hard part. The hard part is, how do you make a flying car that is super safe and quiet? Because if it is a howler, you are going to make people unhappy». *Elon Musk*



«Environmentally friendly and affordable air taxis can make an important contribution to mobility in our conurbations. The Silent Air Taxi, a quiet and low-emission hybrid small aircraft, is the next innovation of alternative and climate-friendly mobility solutions «made in North Rhine-Westphalia». It is always impressive to see how stakeholders from academia and industry work closely together to develop concrete, everyday technologies for sustainable mobility from futuristic visions. This is how scientific excellence is translated into industrial production». *Armin Laschet*

VII. In groups, discuss the following issues. Justify your point of view.

1. Advantages and disadvantages of flying taxis as a new means of transport.
2. The possibility and necessity of the development of this type of transport in Belarus.
3. The future of traditional public transport and its possible improvement with AI technologies.

Present your ideas to your groupmates.

GRAMMAR FOCUS 2

4.4.3. Признаки распознавания субъектного инфинитивного оборота (сложного подлежащего/Complex Subject)

1	2	3
C	СК	to x

C – субъект (подлежащее), СК – сказуемое.

Позицию 2 занимают следующие глаголы в пассивной форме:

is/are assumed	допускается/-ют	is/are held	полагается/-ют
is/are believed	полагается/-ют	is/are reported	сообщается/-ют
is/are claimed	утверждается/-ют	is/are seen	видно
is/are considered	считается/-ют	is/are stated	утверждается/-ют
is/are expected	ожидается/-ют	is/are supposed	предполагается/-ют
is/are estimated	считается/-ют	is/are taken	полагается/-ют
is/are found	обнаруживается	is/are thought	полагается/-ют

The students are reported **to** *conduct* research well. а. Сообщается, что **эти студенты** *проводят* научное исследование хорошо.
б. **Эти студенты**, как сообщается, *проводят* научное исследование хорошо.

Позицию 2 занимают следующие глаголы в активной форме:

to appear	казаться
to be certain	несомненно, наверняка
to happen	случаться, оказываться
to be likely	вероятно
to be unlikely	маловероятно, вряд ли
to prove	оказываться
to seem	казаться
to be sure	несомненно, конечно, наверняка
to turn out	оказываться

Инфинитив может иметь формы to be xing, to have xed, to be xed, to have been xed.

The conditions seem **to have been** *poorly chosen*. а. Кажется, (что) **эти условия** *были* плохо **выбраны**.
б. **Эти условия**, кажется, *были* плохо **выбраны**.

I. Give the Russian equivalents of the following parts of the sentences. Pay attention to the form of the infinitive in the active/ passive voice.

They are said to fix; she seems to explain; the computer seems to be used; the results are thought to be; the report proved to be; he is said to be testing; the scientist is known to be; his decision seemed to be right; the bug turned out to have been fixed.

II. Define the similarities and differences of the forms of the verbs in bold.

1. The results of the software testing **proved** to be right. 2. The theory **was proved** years after by another scientist. 3. This solution **appears** to be optimal in the

given circumstances. 4. The delegation **appeared** at the doorway as soon as the conference began. 5. The team **seems** to have received an encouraging response from the software consultant. 6. After having completed the task successfully, the software developers **seemed** to be content with the results. 7. The beta-testing **is supposed** to be conducted by the selected candidates. 8. «I **suppose** we can continue fulfilling the targeted aims after the chip’s development is completed», said the professor. 9. They participated in the medical technologies conference where they **happened** to initiate a fruitful partnership. 10. The worldwide introduction of the new chip **happened** very rapidly.

III. Compare the form and meaning of the infinitives. Give the Russian equivalents of the following sentences.

1. They seem to have been given positive feedback on their research project. 2. They appear to have been discussing the issues since 2 o’clock. 3. The team was expected to complete the task by the end of the quarter. 4. He is said to have worked at this laboratory. 5. The output proved to have increased. 6. The output is likely to increase and contribute to the project overall efficiency. 7. He is said to be testing a new device. 8. He is said to have tested a new device for electronic industry. 9. He is reported to have grown a new type of crystal. 10. He is reported to be growing a new type of crystal.

IV. Give the Russian equivalents of the following sentences.

1. The delegation is informed to have already arrived. 2. The experiment is said to have been conducted. 3. The answer is unlikely to please you. 4. The invention is believed to dramatically change the role of the traditional newscaster. 5. Even the more sophisticated computational systems are unlikely to substitute the human brain. 6. The technique’s success turns out to be costly. 7. A new chip is considered to render complex graphics in real time. 8. He seems to be soldering now. 9. For the last few decades the research area seems to have been studied thoroughly.

4.4.4. Признаки распознавания объектного инфинитивного оборота (сложного дополнения/Complex Object)

1	2	3	4
C	СК	<u>O</u>	<u>to x</u>

C – субъект, подлежащее, СК – сказуемое, O – объект, дополнение.

Позицию 3 занимает существительное или местоимение в объектном падеже *me, you, him, her, it, us, them*.

После глаголов *to see* (видеть), *to hear* (слышать), *to feel* (чувствовать), *to observe, to watch* (наблюдать), *to notice* (замечать), *to make* (заставлять), *to let* (позволять) инфинитив употребляется без частицы *to*.

His supervisor wanted **him to take part** in the conference.

Его руководитель хотел, **чтобы он принял участие** в конференции.

Позицию 2 занимают следующие глаголы:

to allow	разрешать
to assume	предполагать, допускать
to believe	полагать
to cause	заставлять, вызывать
to command	приказывать
to consider	считать
to demand	требовать
to enable	давать возможность
to expect	ожидать, полагать
should/would like	хотелось бы
to make	заставлять, вызывать
to permit	разрешать
to prove	доказывать, оказываться
to request	просить
to require	требовать
to suppose	полагать
to wish	желать

V. Define the similarities and differences of the parts of the sentences in bold. Give their Russian equivalents.

1. We know **the scientist to investigate** this problem thoroughly. 2. We did not know that **he was responsible for this experiment**. 3. She heard that **he mentioned the problem several times**. 4. She heard **him enjoy** making reports at scientific conferences. 5. Nowadays we see that **scientists change fields of research**. 6. The research team saw **the device begin to operate**. 7. We felt **this suggestion be** wrong. 8. I felt that **the results were satisfactory**. 9. We thought **him to be talking** to an employer. 10. We thought that **they were working at the University**. 11. We knew **them to be working** on the project.

VI. Find Complex Object in each sentence. Give the Russian equivalents of the sentences.

1. I suppose her to be an experienced software engineer able to perform the task efficiently. 2. The chief engineer demanded the workers to observe the safety rules. 3. We expected him to mention the latest data in his report. 4. They saw him perform the experiment in a matter of minutes that contributed to his reputation of the best scientist in the group. 5. We know silver to be the best of conducting materials. 6. We expect the article to be published next year. 7. I believe him to have changed the direction of the research in compliance with the new requirements. 8. We watched the robot perform many operations.

READING 3

I. Scan the text and define its main theme.

AUGMENTED REALITY (AR) VS. VIRTUAL REALITY (VR): WHAT'S THE DIFFERENCE?

1. The terms «virtual reality» and «augmented reality» get thrown around a lot. VR headsets, such as the Oculus Quest or Valve Index, and AR apps and games, such as Pokemon Go, are still popular. They sound similar, and as the technologies develop, they bleed into each other a bit. However, they're two very different concepts, with characteristics that readily distinguish one from the other.

2. **What Is Virtual Reality?** VR headsets completely take over your vision to give you the impression that you're somewhere else. The HTC Vive Cosmos, the PlayStation VR, the Oculus Quest, the Valve Index, and other headsets are opaque, blocking out your surroundings when you wear them. If you put them on when they're turned off, you might think you're blindfolded.

3. When the headsets turn on, however, the LCD or OLED panels inside are refracted by the lenses to fill your field of vision with whatever is being displayed. It can be a game, a 360-degree video, or just the virtual space of the platforms interfaces. Visually, you're taken to wherever the headset wants you to go – the outside world is replaced with a virtual one.



Oculus Quest 2

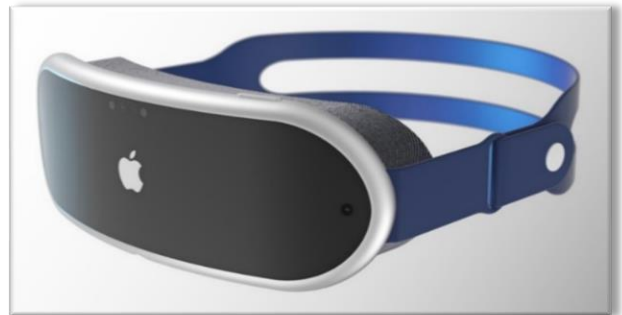

Apple's VR headset

4. Tethered VR headsets, such as the Index and PS VR, and standalone VR headsets, such as the Quest 2, use six-degrees-of-freedom (6DOF) motion tracking. That tech comes courtesy of external sensors or cameras or outward-facing cameras (for the Quest 2). This means the headsets don't just detect the direction in which you're facing, but any movement you make in those directions. This, combined with 6DOF motion controllers, lets you move around in a virtual space, with virtual hands. This space is usually limited to a few square meters across, but it's much more immersive than just standing still and looking in different directions. The drawback is that you need to be careful not to trip over any cable that connects the headset to your computer or game system.

5. For both games and apps, virtual reality supersedes your surroundings, taking you to other places. Where you are physically doesn't matter. In games, you might sit in the cockpit of a star fighter. In apps, you might virtually tour distant locations as if

you were there. There are tons of possibilities in VR, and they all involve replacing everything around you with something else.

6. What Is Augmented Reality? Whereas virtual reality replaces your vision, augmented reality adds to it. AR devices, such as the Microsoft HoloLens and various enterprise-level «smart glasses», are transparent, letting you see everything in front of you as if you are wearing a weak pair of sunglasses.



Microsoft HoloLens

7. The technology is designed for free movement, while projecting images over whatever you look at. The concept extends to smartphones with AR apps and games, such as Pokemon Go, which use your phone camera to track your surroundings and overlay additional information on top of it, on the screen.

8. AR displays can offer something as simple as a data overlay that shows the time, to something as complicated as holograms floating in the middle of a room. Pokemon Go projects a Pokemon on your screen, on top of whatever the camera is looking at. The HoloLens and other smart glasses, meanwhile, let you virtually place floating app windows and 3D decorations around you.

9. This technology has a distinct disadvantage compared with virtual reality: visual immersion. While VR completely covers and replaces your field of vision, AR apps only show up on your smartphone or tablet screen, and even the HoloLens can only project images in a limited area in front of your eyes. It isn't very immersive when a hologram disappears once it moves out of a rectangle in the middle of your vision, or when you must stare at a small screen while pretending that the object on that screen is in front of you.

10. Basic AR that overlays simple information over what you're looking at can function perfectly fine with 3DOF. However, most AR applications require 6DOF in some form, tracking your physical position so the software can maintain consistent positions for the images it projects in 3D space. This is why the HoloLens uses a stereoscopic camera and advanced pattern recognition to determine where it is at all times, and why more advanced, AR-centric smartphones use multiple rear-facing cameras to track depth.

11. Augmented reality has nearly limitless possibilities. Phone-based AR software has been recognizing surroundings and providing additional information about what it sees for years now, offering live translation of text or pop-up reviews of restaurants as you look at them. Dedicated AR headsets, such as the HoloLens, can do even more, letting you virtually place different apps as floating windows around you. They effectively give you a modular, multi-monitor, computing setup.

12. Currently, AR is only widely available on smartphones, and doesn't have the vision-augmenting aspect of enterprise-level AR displays. This means AR is still very limited, until a consumer AR headset is released.

13. Virtual reality and augmented reality accomplish two very different things in two very different ways, despite their devices' similar designs. VR replaces reality, taking you somewhere else. AR adds to reality, projecting information on top of what you're already seeing. They're both powerful technologies that have yet to make their mark with consumers, but show a lot of promise. They can completely change how we use computers in the future, but whether one or both will succeed, is anyone's guess right now.

(<https://www.pcmag.com/news/augmented-reality-ar-vs-virtual-reality-vr-whats-the-difference>)

Notes:

- *LCD* – Liquid Crystal Display;
- *OLED* – Organic Light Emitting Diode.

II. Define which of the following information is mentioned in the text.

1. The peculiarities of VR technology.
2. The technical challenge of VR and AR headsets production.
3. The main features of 6DOF technology.
4. Mixed reality (MR) as a blend of VR and AR for entertainment.
5. The distinctiveness of AR technology.
6. Apple's secret virtual and augmented reality projects.
7. The possibilities of VR and AR technologies.
8. AR, MR, VR as the forms of extended reality (ER).

III. Read the text again and define whether the following facts are considered in it.

1. Strapping on a VR headset is a fantastic experience. It's so realistic that you almost feel as if you're visiting a location or taking part in an activity.
2. VR products are mostly very expensive and the cost usually depends on the scope of the project.
3. Typically, virtual reality is associated with computer games. However, it can provide some of the best and most interesting VR opportunities like travelling experience.
4. Unlike VR, AR superimposes virtual objects on physical elements to enhance your current perception of the reality.
5. AR has its vast potential. A user needs only a smartphone and AR headsets.
6. VR and AR are transforming industries through software and hardware development, graphic design, research, and more. Thus, in-demand careers developing and improving VR and AR technologies include software engineering and development, project management, software maintenance and graphic design.

IV. Find the passages containing the information about VR and AR features. Explain the main differences between these two technologies.

V. Look through the text and name the drawback of AR in comparison with VR. Comment on it.

VI. Find the passage about vast opportunities of AR and describe them.

VII. Give the main points of the text in 5-6 sentences.

VIII. Express your opinion on VR and AR technologies. Say if you have ever tried any of the products mentioned in the text. Share your impressions with your groupmates. Would you like to buy products with VR or AR? Why/Why not?

SUMMARY WRITING

I. Read the text and write a short summary of it.

ROBOTIC HAND CAN CRUSH BEER CANS AND HOLD EGGS WITHOUT BREAKING THEM

A robot hand that has the lightness of touch to hold delicate objects and the strength to crush cans could one day be used as a prosthetic

By Carissa Wong

A highly dexterous, human-like robotic hand with fingertip touch sensors can delicately hold eggs, use tweezers to pick up computer chips and crush drink cans. The hand could eventually be used as a prosthetic or in robots that use artificial intelligence to manipulate objects.

Weighing 1.1 kilograms, the hand is 22 centimetres long and made of steel and aluminium. Each finger is driven by three small motors that fit within the palm and move metal parts that act like tendons around a total of 20 joints. This enables the digits to tilt sideways, to flex back and forth and to fold, giving the hand a range of movements comparable to that of a human hand.

Uikyum Kim at Ajou University in South Korea and his colleagues, who built the hand, say it can hold an egg without cracking it, pour drinks and crush aluminium cans.

The researchers also tested whether the robotic hand could use tools. They found it can: it could be programmed to hold a pair of scissors and cut paper, and

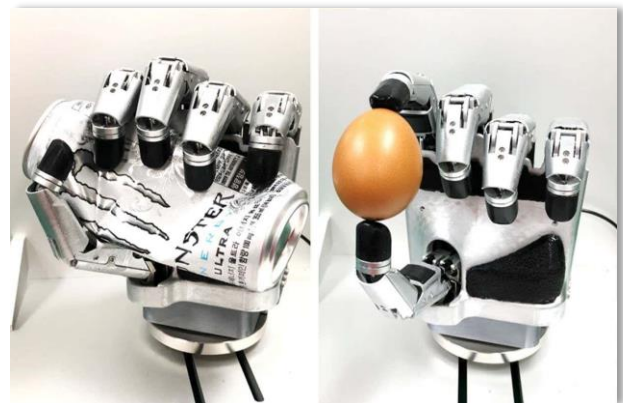

The robot hand in action

also to manipulate tweezers to pick up and place a microchip on a circuit board.

«Can I really manipulate the tweezers on my desk? I was curious. I remember being very satisfied with the moment that [it worked]», says Kim.

Compared with existing robotic hands, the base of the hand can more easily attach to commercial robotic arms.

«The greatest strength of the developed robotic hand is that it is very easy to attach to existing commercial robot arms while having both strong grip and delicacy», says Kim.

He and his colleagues also tested the durability of the robotic hand by

programming a finger to push down onto a sensor constantly for 30 minutes. They found that the force applied by the finger hardly weakened during this time.

Next, they used the hand to pick up dumbbells weighing 18 kilograms, which it could do without breaking. In another test, they programmed one of the robot fingers to bend and flex repeatedly to press a sensor every second for 11 minutes. It did

so throughout that time without slowing or losing force.

In future, the hand could form part of intelligent robots capable of sensing and manipulating objects, while a lighter version of the hand could be used as a prosthetic.

However, this prototype currently lacks softness compared with a human hand, so the team hopes to develop a flexible artificial skin, says Kim.

(New Scientist, 14 December 2021)

(<https://www.newscientist.com/article/2301641-robotic-hand-can-crush-beer-cans-and-hold-eggs-without-breaking-them/amp>)

ADDITIONAL ACTIVITY

Watch the video about the described robotic hand in action.



<https://www.youtube.com/watch?v=TJzfgipEACU&t=1s>

FOLLOW UP

I. A. Work in groups and find the information on the Internet about the following most popular AI projects.



Siri



B. Fill in the table below to organize your ideas.

Name and type of AI software product	Features	Pros	Cons

C. Discuss these AI software products using the information from the table. Give arguments to support your opinion. Share the facts you've learnt with the rest of the group.

II. Role play the following situation in small groups. Prove your ideas.

You are a computer geek. You are involved in the designing of a real robot with Artificial Intelligence abilities. The robot you are planning to design will teach people foreign languages and become an efficient assistant with teaching functions. This robot is going to teach any foreign language as a second one. You strongly believe that this technology will motivate people to start learning foreign languages and will ease this process. You are going to participate in an international exhibition where the potential clients would like to buy your product. Make up a presentation advertising your robot and be ready to answer the questions about the functional abilities, how robot is charged, its maintenance and service, the price on the market, and more.

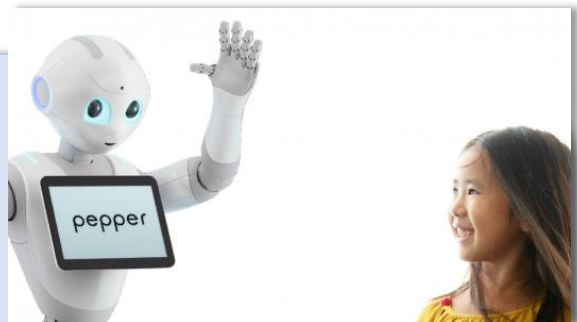

Student A

You are businessmen who are interested in buying AI robots for your company employees. The staff in your companies cooperate with partners all over the world and you want them to improve their foreign language skills. There are some points you would like to clear out before buying the robot:

1. The functional abilities of the robot.
2. The way the robot is charged and whether it is an energy-efficient product or not.
3. Its maintenance and service.
4. Its possible disadvantages.
5. The price on the market.

Other Students

Use the links to get more ideas:



<https://builtin.com/robotics-in-the-classroom>



<https://therocketsscience.com/the-advantages-and-disadvantages-of-replacing-teachers-with-robots>



<https://www.proshareng.com/news/Education%20Knowledge/Advantages-and-Disadvantages-of-Robot-Teachers/56965>

III. Comment and express your opinion on the following prediction:

- It is forecast that one day robots can replace real teachers.

Provide arguments in favour or against this point of view.

IV. You have read a post on the Internet site announcing University Student Forum devoted to the theme: «The Future Development of Artificial Intelligence: its Impact on People's Life». The themes covered at the Forum sessions will be as follows:

- Famous scientists and entrepreneurs, their contribution to AI development.
- The Impact of AI on Future Work and Life: will AI dismantle the human workforce?
- Artificial Intelligence: The Moral Code of AI.
- Real robots that will make you think the future is now.
- The near-human or better-than-human abilities of AI.

The Forum will take place in a virtual setting (Zoom) and will be an hour in length.

You have decided to join this thought-provoking forum which judging by the agenda will provide an opportunity to exchange ideas, learn cutting-edge information, network with peers and experts while engaging in a variety of discussions related to the field. You've chosen to make a report with a slide-show presentation of its key points.

Search for the necessary information on the Internet and be ready to inform the participants of the Forum about your ideas, results and conclusions. Think over possible questions that can be asked as you are interested in getting feedback from experts.

FINAL ACTIVITY

SPEAKING (MODULES 1–4)

Practice makes perfect.
An English proverb

Revise the material studied in Modules 1–4 and be ready to play one of the following games.



Guess the Word



Quiz

APPENDIX

Словообразование Word Formation

Образование глаголов путем конверсии

<i>Существительное</i>	<i>Глагол</i>
change – изменение	to change – менять
lecture – лекция	to lecture – читать лекцию
<i>Прилагательное</i>	<i>Глагол</i>
empty – пустой	to empty – опустошать
clean – чистый	to clean – чистить

Образование глаголов путем изменения места ударения

<i>Существительное</i>	<i>Глагол</i>
'export – экспорт	to ex'port – экспортировать
'contest – спор	to con'test – оспаривать

Образование глаголов путем чередования звуков

<i>Существительное</i>	<i>Глагол</i>
use /ju:s/ – использование	to use /ju:z/ – использовать
house /haus/ – дом, жилище	to house /hauz/ – поселить, размещать

Образование глаголов путем присоединения префиксов

<p><i>противоположное действие:</i></p> <p>dis-</p> <p>un-</p> <p>de-</p> <p><i>«неверно, неправильно»:</i></p> <p>mis-</p> <p><i>«снова, заново, вновь»:</i></p> <p>re-</p> <p><i>«сверх, чрезмерно»:</i></p> <p>over-</p> <p><i>«перед, ранее»:</i></p> <p>pre-</p> <p><i>для образования глагола:</i></p> <p>en-</p>	<p>to connect – соединять</p> <p>to trust – доверять</p> <p>to lock – запираеть</p> <p>to code – кодировать</p> <p>to apply – использовать</p> <p>to hear – слышать</p> <p>to attach – присоединять</p> <p>to write – писать</p> <p>to load – грузить</p> <p>to charge – заряжать</p> <p>large – большой</p> <p>circle – круг</p>	<p>to disconnect – разъединять</p> <p>to distrust – не доверять</p> <p>to unlock – отпирать</p> <p>to decode – декодировать</p> <p>to misapply – неверно использовать</p> <p>to mishear – ослышаться</p> <p>to reattach – повторно присоединять</p> <p>to rewrite – переписать</p> <p>to overload – перегружать</p> <p>to precharge – предварительно заряжать</p> <p>to enlarge – увеличить</p> <p>to encircle – окружать</p>
---	---	---

Образование глаголов путем присоединения суффиксов

<p>-ate</p> <p>-ify</p> <p>-en</p> <p>-ize</p>	<p>active – активный</p> <p>simple – простой</p> <p>short – короткий</p> <p>strength – сила</p> <p>character – характер</p>	<p>to activate – активизировать</p> <p>to simplify – упрощать</p> <p>to shorten – укорачивать</p> <p>to strengthen – усиливать</p> <p>to characterize – характеризовать</p>
--	---	--

Словообразовательные суффиксы существительных

	<i>Глагол:</i>	<i>Существительное, обозначающее лицо или механизм, производящие действие:</i>
-or	to operate – работать	operator – оператор
-er	to transmit – передавать	transmitter – передатчик
		<i>Существительное обозначает лицо, на которое направлено действие:</i>
-ee	to employ – нанимать	employee – сотрудник
-ent	to study – изучать	student – студент
-ant	to assist – помогать	assistant – помощник
		<i>Существительные отвлеченные, обозначающие общие понятия (процессы состояния, свойства и т. п.)</i>
-ion	to construct – строить	construction – строительство
-tion	to produce – производить	production – производство
-ation	to combine – соединять, совмещать	combination – комбинация, сочетание
-sion	to decide – решать	decision – решение
-ssion	to admit – допускать	admission – допущение
-ment	to move – двигать(ся)	movement – движение
-ure	to press – давить	pressure – давление
-ance	to perform – выполнять	performance – производительность, рабочая характеристика
-ence	to differ – отличаться	difference – различие
-age	to pass – проходить	passage – проход
		<i>Существительные, указывающие на профессию:</i>
-ist	to type – печатать	typist – машинистка
-yst	to analyze – анализировать	analyst – аналитик
-ian	electricity – электричество	electrician – электрик
	<i>Прилагательное:</i>	<i>Существительные абстрактные, обозначающие общие понятия, качество и т. п.:</i>
-ness	effective – эффективный	effectiveness – эффективность
-ity	active – активный	activity – активность
-ty	safe – безопасный	safety – безопасность
-th (с изменением гласной)	long – длинный	length – длина
	<i>Прилагательное и существительное:</i>	<i>Существительное отвлеченное:</i>
-dom	free – свободный	freedom – свобода
-ship	leader – вождь, руководитель	leadership – руководство
-ism	patriot – патриот	patriotism – патриотизм
	<i>Существительное:</i>	<i>Указывает на национальность:</i>
-ian	Belarus – Беларусь	Belarusian – белорус
-ese	Japan – Япония	Japanese – японец

Словообразовательные суффиксы прилагательных

a) образованные от существительных:

-en	gold	золото	golden	золотой
-ic	history	история	historic	исторический
-al	logics	логика	logical	логичный
-ful	use	польза	useful	полезный
-ly	day	день	daily	ежедневный
	friend	друг	friendly	дружеский
-less	use	польза	useless	бесполезный
	truth	правда	truthless	ложный
-ous	fame	известность	famous	известный
	danger	опасность	dangerous	опасный

b) образованные от глаголов:

-able	to move	двигаться	moveable	подвижный
-ible	to sense	понимать, осознавать	sensible	разумный, благоразумный
-ant	to resist	сопротивляться	resistant	сопротивляющийся
-ent	to depend	зависеть	dependent	зависимый
-ive	to create	создавать	creative	созидательный
-tive	to talk	разговаривать	talkative	разговорчивый

REFERENCES

1. Фоломкина, С. К. Обучение чтению на иностранном языке в неязыковом вузе : учеб.-метод. пособие / С. К. Фоломкина ; науч. ред. Н. И. Гез. – 2-е изд., испр. – М. : Высш. шк., 2005. – 253 с.
2. Милашевич, В. В. Обучение научно-техническому переводу с английского языка. Часть II : Логическое изучение грамматики : метод. рекомендации. – 10-е изд., перераб. Владивосток : ДВО АН СССР – НТТМ «Техника», 1988. – 41 с.
3. Английский язык: пособие по обучению чтению и пониманию научно-технической литературы (на основе модульной технологии) = The English Language: Practical Hand-book for Teaching Students to Read and Understand Science Literature with the Use of Module Technology : пособие / Е. И. Лозицкая [и др.]. – Минск : БГУИР, 2016. – 136 с.
4. Academic Dictionaries and Encyclopedias [Electronic resource]. – 2021. – Mode of access : <http://universalium.academic.ru>.
5. Study.com. English Learning Resource [Electronic resource]. – 2021. – Mode of access : <https://study.com>.

CONTENTS

ПРЕДИСЛОВИЕ	3
BOOK MAP	5
MODULE 1. ELECTRONICS	6
Part I. Electronic Technologies	6
Part II. Electronics Application	32
MODULE 2. TELECOMMUNICATIONS	56
Part I. Networking	56
Part II. Wireless Communication	84
MODULE 3. INFORMATION TECHNOLOGIES	108
Part I. Operating Systems and Programming Languages	108
Part II. Cutting Edge Technologies and Cyber Security	126
MODULE 4. ARTIFICIAL INTELLIGENCE	151
Part I. Basic AI Concepts	151
Part II. AI in Everyday Life	177
FINAL ACTIVITY	203
APPENDIX	204
REFERENCES	207

Учебное издание

Маликова Ирина Гаврииловна
Лихтарович Ирина Ильгизовна
Левкович Татьяна Викторовна и др.

**ПРАКТИЧЕСКИЙ КУРС АНГЛИЙСКОГО ЯЗЫКА
ДЛЯ СТУДЕНТОВ ИНЖЕНЕРНЫХ СПЕЦИАЛЬНОСТЕЙ**

**PRACTICAL ENGLISH COURSE FOR ENGINEERING
STUDENTS**

ПОСОБИЕ

Редактор *Е. С. Юрец*
Компьютерная правка, оригинал-макет

Подписано в печать _____ Формат 60x84 1/16. Бумага офсетная. Гарнитура «Таймс».
Отпечатано на ризографе. Усл. печ. л. __ Уч.-изд. 13. Тираж 250 экз. Заказ

Издатель и полиграфическое исполнение: учреждение образования
«Белорусский государственный университет информатики и радиоэлектроники».
Свидетельство о государственной регистрации издателя, изготовителя,
распространителя печатных изданий №1/238 от 24.03.2014,
№2/113 от 07.04.2014, №3/615 от 07.04.2014.
ЛП №02330/264 от 14.04.2014.
Ул. П. Бровки, 6220013, г. Минск

